



catalogo listino **2021** catalogue price list



**ARTECLIMA**  
Hydronic Systems



catalogo listino **2021** catalogue price list



**ARTECLIMA**  
Hydronic Systems

PROUDLY MADE IN ITALY

<b>Componenti per impianti di riscaldamento e idro-sanitari</b>	<b>77</b>
<i>Heating and water/sanitary systems components</i>	
<b>Schede tecniche</b>	<b>177</b>
<i>Technical tables</i>	

### Legenda

Misura / Dimensione		<i>Measure / size</i>
Diametro tubo		<i>Pipe size</i>
Vie		<i>Ways</i>
Grado di filtrazione		<i>Grade of filtration</i>
Portata nominale		<i>Nominal flow rate</i>
Lunghezza		<i>Length</i>
Mandata		<i>Inlet</i>
Confezione		<i>Pieces</i>
Imballo		<i>Boxing</i>
Prezzo		<i>Price</i>

### Legend



Arteclima è un marchio del made in Italy: proposte e soluzioni per il settore idro-termo-sanitario sempre al passo con l'evoluzione del mercato. Prodotti pensati per migliorare la qualità della vita, altamente affidabili, ergonomici e funzionali, nonché stilisticamente all'avanguardia. L'intero processo aziendale, a partire dalla progettazione fino alla produzione dei Componenti Idrotermici Arteclima®, è certificato secondo la norma "UNI EN ISO 9001:2015", a garanzia di un presidio costante della qualità dei nostri prodotti e di un servizio pre e post vendita estremamente accurato. La nostra ambizione infatti è di instaurare con Clienti e Fornitori un rapporto di partnership e di quotidiana collaborazione evidenziando l'entusiasmo e la passione che guida ed alimenta ogni giorno il nostro impegno.





**ICIM**

CISQ is a member of



**IQNet**

**CERTIFICATO n. 480712**  
**CERTIFICATE No. 480712**

SI CERTIFICA CHE IL SISTEMA DI GESTIONE PER LA QUALITÀ DI  
 WE HEREBY CERTIFY THAT THE QUALITY MANAGEMENT SYSTEM OPERATED BY

**ARTECLIMA S.r.l.**  
 UNITÀ OPERATIVE / OPERATIVE UNITS

Via T. Cagnola, 15 - 28024 Gozzano (NO)  
 Italia

E' CONFORME ALLA NORMA / IS IS IN COMPLIANCE WITH THE STANDARD:

**UNI EN ISO 9001:2015**

Sistema di Gestione per la Qualità / Quality Management System  
 PER LE SEGUENTI ATTIVITÀ / FOR THE FOLLOWING ACTIVITIES

**EA: 18**

Progettazione e produzione di componenti idrotermici  
 Design and production of hydnric components

Questo documento è di proprietà di CISQ e può essere ristampato per scopi educativi o di ricerca. Non è permesso l'uso commerciale. Questo documento è di proprietà di CISQ e può essere ristampato per scopi educativi o di ricerca. Non è permesso l'uso commerciale. Questo documento è di proprietà di CISQ e può essere ristampato per scopi educativi o di ricerca. Non è permesso l'uso commerciale.

For more information on the requirements of the ISO 9001:2015 standard, please refer to the original certificate issued by CISQ/ICIM SPA.

Data emissione Print Issue 18/01/2008	Emissione corrente Current Issue 18/01/2018	Data di scadenza Expiring date 18/01/2021
---	---	---

  
 Alex Stachivola  
 President of IQNET







**THE INTERNATIONAL CERTIFICATION NETWORK**

**CERTIFICATE**

**CISQ/ICIM SPA as an IQNet Partner hereby states that the organization:**

**ARTECLIMA S.r.l.**

Via T. Cagnola, 15 - I-28024 Gozzano (NO)

for the following scope:

**Design and production of hydronic components.**

has implemented and maintains a

**Quality Management System**

which fulfils the requirements of the following standard:

**ISO 9001:2015**

Issued on: 2018-01-19  
 First issued on: 2009-01-19

For the validity date, please refer to the original certificate issued by CISQ/ICIM SPA.

Registration Number: IT-53768

  
 Alex Stachivola  
 President of IQNET



  
 Ing. Claudio Proven  
 President of CISQ

IQNet Partner\*\*

AFNOR Spain AFNOR Certification France APCER Portugal CCC Cyprus CSQ India  
 CQC China CCM China CQB Czech Republic CCA USA C Canada CQI Holding GmbH Germany PCW Brazil  
 TÜRKAK BIAA Guatemala ISONTEC Colombia Ingeniería Certificación Finland FINTECO Costa Rica  
 IRAM Argentina KQA Japan KQA Korea MBRTK Greece MUTI Hungary Svanvik AS Norway NVAI Iceland PCEC Poland  
 Quality Austria Austria ISM Russia SQR Mexico SII Israel IQI Germany ISIRIQA QAS International Malaysia  
 MSA Switzerland BSC Romania TSET in Penningburg Russia VSE Turkey Vsechna Belgien VQS Serbia  
 IQNet is represented in the USA by: AFNOR Certification, CISO, DQS Holding GmbH and NSAI Inc.

\* This attention is drawn to the fact that the IQNet Partner's original certificate and shall not be used as a stand-alone document.

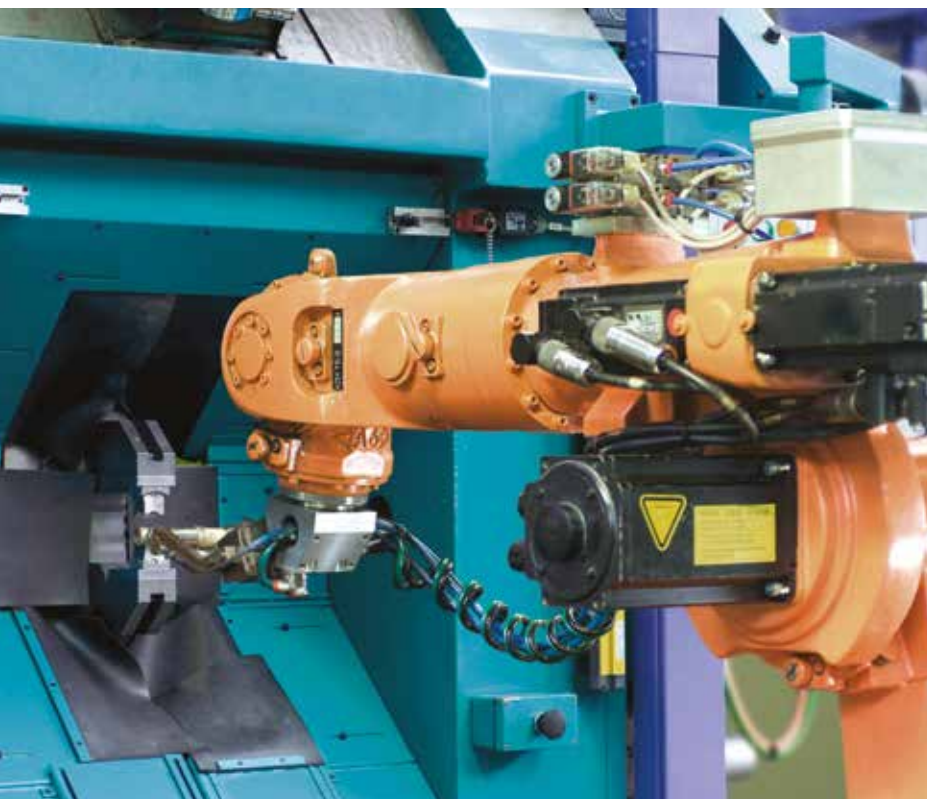
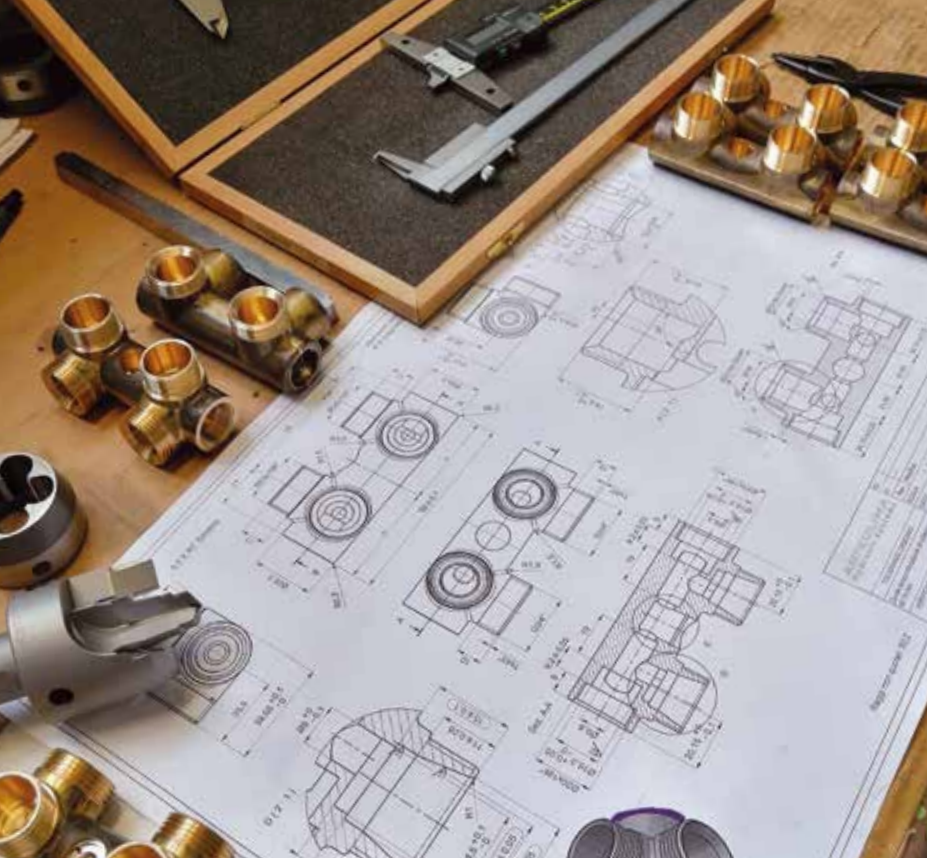
\*\* The list of IQNet partners is valid at the time of issue of this certificate. Updated information is available under www.iqnet-certification.com



*Arteclima is a brand Made in Italy: devise and propose solutions in Hydro-Thermo-Sanitary sector, always behind the times with the evolution of the market. Products designed to improve the quality of life, highly reliable, ergonomic and functional, as well as stylistically advanced. The whole business process, starting from the design to the production of Arteclima® Hydrothermic products, is according to the "UNI EN ISO 9001:2015" certification to guarantee a constant quality of our products and an accurate assistance service before and after the sale. Our ambition is to establish a relationship of collaboration and partnership with our customers and suppliers, highlighting enthusiasm and passion which guides and feeds our commitment every day.*







# Componenti per impianti di riscaldamento e idro-sanitari

*Components  
for heating  
and water-sanitary  
installations*





## Valvole e detentori

Comandi termostatici	80
Sistema VISION	82
Kit termostatici	84
Valvole termostattizzabili e detentori	86
Valvole termostattizzabili e detentori con attacco tubo ferro	87
Valvole termostattizzabili con preregolazione	91
Valvole manuali e detentori	92
Valvole manuali e detentori con attacco tubo ferro	93
Valvole termostattizzabili monotubo e bitubo	96
Raccordi per tubo rame, plastica e multistrato	97
Accessori e ricambi	98

## Valves and lockshields

<i>Thermostatic heads</i>	80
<i>VISION system</i>	82
<i>Thermostatic kit</i>	84
<i>Radiator valves with thermostatic option and lockshields</i>	86
<i>Radiator valves with thermostatic option and lockshields with iron pipe connection</i>	87
<i>Presetting valves with thermostatic option</i>	91
<i>Manual valves and lockshields</i>	92
<i>Manual valves and lockshields with iron pipe connection</i>	93
<i>Single/double pipe valves with thermostatic option</i>	96
<i>Fittings for copper pipe, plastic pipe and multilayer pipe</i>	97
<i>Accessories and spare-parts</i>	98





Comando termostatico con sensore a liquido incorporato e possibilità di blocco della temperatura.

*Thermostatic head with integrated liquid sensor and possibility of blocking the temperature*

<b>39001</b>			
39001	M30x1,5	1	50

Guscio antimanomissione e antifurto per comando termostatico 39001.

*Anti-tampering and anti-theft shell for thermostatic head 39001.*

<b>391</b>			
39130	30	1	50



Guscio antimanomissione e antifurto per impieghi in locali pubblici  
*Anti-tampering and anti-theft shell for use in public places*

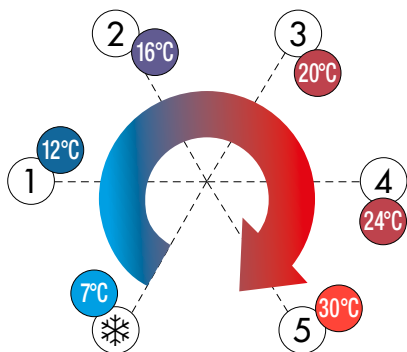

Comando termostatico con sensore a distanza.  
Lunghezza del capillare trasmettitore 2 m.

*Thermostatic head with remote sensor.  
Length of capillary emitter 2 m.*

<b>312</b>			
31212	M30x1,5	1	10

Comando termostatico digitale programmabile con sensore incorporato. Compatibilità valvole: M30x1,5. Alimentazione a batteria 2AA.

*Programmable digital thermostatic head with integrated sensor.  
Valve compatibility: M30x1.5 - 2AA battery powered.*

<b>313</b>			
31330	M30x1,5	1	20



Valvola by-pass differenziale diritta.  
*Straight differential by-pass valve.*

<b>4035</b>			
403534	3/4"	1	-

Valvola by-pass differenziale a squadra.  
*Angle differential by-pass valve.*

<b>4030</b>			
403034	3/4"	1	-



Azionatore elettrotermico attacco M30 x 1,5.  
Alimentazione a 230 V. (Normalmente chiuso).

*Electrothermal actuator, connection M30 x 1,5.  
Voltage 230 V. (Normally closed).*

<b>315</b>			
31523S	230 V - 4 fili	1	50
31623	230 V - 2 fili	1	50



## ARTECLIMA VISION: tutto sotto controllo



**Gestione da Smartphone**  
(Applicazione iOS e Android)







Unità Centrale touch screen a colori, 4.3" con comunicazione RF (868MHz) e Wi-Fi (2,4GHz) per Smart Phone (iOS, Android). Gestisce fino a 50 zone.

<b>1100</b>			
1100	230V-50Hz	1	-



Termostato digitale a radiofrequenza (868 MHz) con display LCD retroilluminato. Alimentazione a batteria 2AA.

<b>1110</b>			
1110	batteria - 2AA	1	-



Ricevitore a incasso. Controlla sistemi di riscaldamento in abbinamento ai termostati radio frequenza Art.1110 oppure tramite l'unità centrale (Art.1100). Alimentazione 230V. 50Hz. Frequenza radio segnale: 868MHz (trasmissione bidirezionale) -Copertura 30 m (ambiente residenziale).

<b>1140</b>			
1140	230V-50Hz	1	-



Comando cronotermostato elettronico. Funzionamento *stand alone* o con sistema Vision (Art.1100 e Art.1110). Schermo LCD con retroilluminazione azzurra, Frequenza radio segnale: 868MHz (trasmissione bidirezionale). Compatibilità valvole: M30x1,5. Alimentazione a batteria 2AA.

<b>370</b>			
370	M30x1,5-2AA	1	10



Ricevitore a muro. Controlla sistemi di riscaldamento in abbinamento ai termostati radio frequenza Art.1110 oppure tramite l'unità centrale (Art.1100). Particolarmente adatto per la gestione della caldaia (consenso di accensione). Alimentazione 230V. 50Hz. Frequenza radio segnale: 868 MHz (trasmissione bidirezionale) -Copertura 30m (ambiente residenziale).

<b>1130</b>			
1130	230V-50Hz	1	-



Ricevitore con presa di corrente shuko per gestire dispositivi elettrici. Alimentazione 230V. 50Hz. Uscita (presa shuko): Max 16A - 250V. Frequenza radio segnale: 868MHz (trasmissione bidirezionale). Copertura 30m (ambiente residenziale).

<b>1120</b>			
1120	230V-50Hz	1	-



Kit termostatico composto da: valvola termostattizzabile, detentore e comando termostatico con sensore incorporato. Attacchi tubo rame, plastica e multistrato.

*Thermostatic kit composed of: valve with thermostatic option, lockshield and thermostatic head with integrated sensor. Connection for copper, plastic and multilayer pipe.*

<b>250KIT</b>	<b>f</b>	<b>⊗</b>	<b>⊗</b>
250KIT38 <b>ST</b>	3/8"	1	20
250KIT12 <b>ST</b>	1/2"	1	20
250KIT38	3/8"	1	20
250KIT12	1/2"	1	20



Kit termostatico composto da: valvola termostattizzabile, detentore e comando termostatico con sensore incorporato. Attacchi tubo ferro.

*Thermostatic kit composed of: valve with thermostatic option, lockshield and thermostatic head with integrated sensor. Connection for iron pipe.*

<b>260KIT</b>	<b>f</b>	<b>⊗</b>	<b>⊗</b>
260KIT12 <b>ST</b>	1/2"	1	20
260KIT12	1/2"	1	20



Kit termostatico composto da: valvola termostattizzabile, detentore e comando termostatico con sensore incorporato. Attacchi tubo rame, plastica e multistrato.

*Thermostatic kit composed of: valve with thermostatic option, lockshield and thermostatic head with integrated sensor. Connection for copper, plastic and multilayer pipe.*

<b>300KIT</b>	<b>f</b>	<b>⊗</b>	<b>⊗</b>
300KIT38 <b>ST</b>	3/8"	1	20
300KIT12 <b>ST</b>	1/2"	1	20
300KIT38	3/8"	1	20
300KIT12	1/2"	1	20



Kit termostatico composto da: valvola termostattizzabile, detentore e comando termostatico con sensore incorporato. Attacchi tubo ferro.

*Thermostatic kit composed of: valve with thermostatic option, lockshield and thermostatic head with integrated sensor. Connection for iron pipe.*

<b>302KIT</b>	<b>f</b>	<b>⊗</b>	<b>⊗</b>
302KIT38 <b>ST</b>	3/8"	1	20
302KIT12 <b>ST</b>	1/2"	1	20
302KIT38	3/8"	1	20
302KIT12	1/2"	1	20
302KIT34	3/4"	1	20
302KIT1	1"	1	20



Kit termostatico composto da: valvola termostattizzabile, detentore e comando termostatico con sensore incorporato. Attacchi tubo rame, plastica e multistrato.

*Thermostatic kit composed of: valve with thermostatic option, lockshield and thermostatic head with integrated sensor. Connection for copper, plastic and multilayer pipe.*

<b>301KIT</b>	<b>f</b>	<b>⊗</b>	<b>⊗</b>
301KIT38 <b>ST</b>	3/8"	1	20
301KIT12 <b>ST</b>	1/2"	1	20
301KIT38	3/8"	1	20
301KIT12	1/2"	1	20



Kit termostatico composto da: valvola termostattizzabile, detentore e comando termostatico con sensore incorporato. Attacchi tubo ferro.

*Thermostatic kit composed of: valve with thermostatic option, lockshield and thermostatic head with integrated sensor. Connection for iron pipe.*

<b>303KIT</b>	<b>f</b>	<b>⊗</b>	<b>⊗</b>
303KIT38 <b>ST</b>	3/8"	1	20
303KIT12 <b>ST</b>	1/2"	1	20
303KIT38	3/8"	1	20
303KIT12	1/2"	1	20
303KIT34	3/4"	1	20
303KIT1	1"	1	20

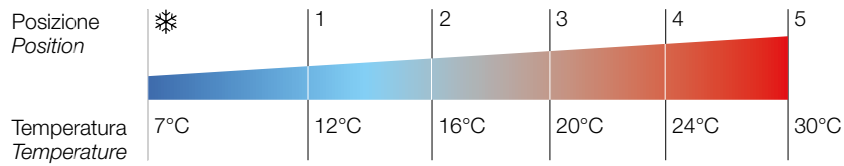

Comando termostatico con possibilità di blocco della temperatura  
Thermostatic control with possibility of blocking the temperature



**MADE IN ITALY**

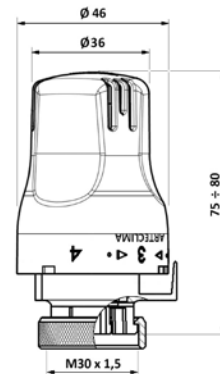

Guscio antimanomissione e antifurto per impieghi in locali pubblici (vedi pag. 80)  
Anti-tampering and anti-theft shell for use in public places (see page 80)

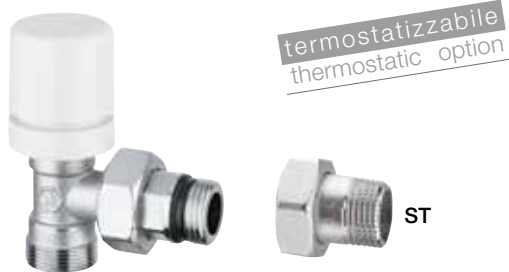

Valvola a squadra cromata termostattizzabile.  
 Attacco tubo rame, plastica e multistrato.

*Chromium-plated angle radiator valve with thermostatic option.  
 Connection for copper, plastic and multilayer pipe.*

<b>250</b>			
25038 <b>ST</b>	3/8"	10	50
25012 <b>ST</b>	1/2"	10	50
25038	3/8"	10	50
25012	1/2"	10	50



Detentore a squadra cromato.  
 Attacco tubo rame, plastica e multistrato.

*Chromium-plated angle lockshield.  
 Connection for copper, plastic and multilayer pipe.*

<b>51</b>			
5138 <b>ST</b>	3/8"	10	50
5112 <b>ST</b>	1/2"	10	50
5138	3/8"	10	50
5112	1/2"	10	50



Valvola a squadra cromata termostattizzabile.  
 Attacco tubo rame, plastica e multistrato.

*Chromium-plated angle radiator valve with thermostatic option.  
 Connection for copper, plastic and multilayer pipe.*

<b>300</b>			
30038 <b>ST</b>	3/8"	10	50
30012 <b>ST</b>	1/2"	10	50
30038	3/8"	10	50
30012	1/2"	10	50



Detentore a squadra cromato.  
 Attacco tubo rame, plastica e multistrato.

*Chromium-plated angle lockshield.  
 Connection for copper, plastic and multilayer pipe.*

<b>110</b>			
11038 <b>ST</b>	3/8"	10	50
11012 <b>ST</b>	1/2"	10	50
11038	3/8"	10	50
11012	1/2"	10	50



Valvola diritta cromata termostattizzabile.  
 Attacco tubo rame, plastica e multistrato.

*Chromium-plated straight radiator valve with thermostatic option.  
 Connection for copper, plastic and multilayer pipe.*

<b>301</b>			
30138 <b>ST</b>	3/8"	10	50
30112 <b>ST</b>	1/2"	10	50
30138	3/8"	10	50
30112	1/2"	10	50



Detentore diritto cromato.  
 Attacco tubo rame, plastica e multistrato.

*Chromium-plated straight lockshield.  
 Connection for copper, plastic and multilayer pipe.*

<b>130</b>			
13038 <b>ST</b>	3/8"	10	50
13012 <b>ST</b>	1/2"	10	50
13038	3/8"	10	50
13012	1/2"	10	50



Valvola a squadra cromata termostattizzabile.  
 Attacco tubo ferro.  
 Chromium-plated angle radiator valve with thermostatic option.  
 Connection for iron pipe.

<b>260</b>			
26012 <b>ST</b>	1/2"	10	50
26012	1/2"	10	50



Detentore a squadra cromato.  
 Attacco tubo ferro.  
 Chromium-plated angle lockshield.  
 Connection for iron pipe.

<b>61</b>			
6112 <b>ST</b>	1/2"	10	50
6112	1/2"	10	50



Valvola a squadra cromata termostattizzabile.  
 Attacco tubo ferro.  
 Chromium-plated angle radiator valve with thermostatic option.  
 Connection for iron pipe.

<b>302</b>			
30238 <b>ST</b>	3/8"	10	50
30212 <b>ST</b>	1/2"	10	50
30238	3/8"	10	50
30212	1/2"	10	50
30234	3/4"	10	50
3021	1"	5	25



Detentore a squadra cromato.  
 Attacco tubo ferro.  
 Chromium-plated angle lockshield.  
 Connection for iron pipe.

<b>210</b>			
21038 <b>ST</b>	3/8"	10	50
21012 <b>ST</b>	1/2"	10	50
21038	3/8"	10	50
21012	1/2"	10	50
21034	3/4"	10	50
2101	1"	5	25



Valvola diritta cromata termostattizzabile.  
 Attacco tubo ferro.  
 Straight chromium-plated radiator valve with thermostatic option.  
 Connection for iron pipe

<b>303</b>			
30338 <b>ST</b>	3/8"	10	50
30312 <b>ST</b>	1/2"	10	50
30338	3/8"	10	50
30312	1/2"	10	50
30334	3/4"	10	50
3031	1"	5	25



Detentore diritto cromato.  
 Attacco tubo ferro.  
 Straight chromium-plated lockshield.  
 Connection for iron pipe.

<b>230</b>			
23038 <b>ST</b>	3/8"	10	50
23012 <b>ST</b>	1/2"	10	50
23038	3/8"	10	50
23012	1/2"	10	50
23034	3/4"	10	50
2301	1"	5	25



Valvola termostattizzabile cromata ad angolo, versione sinistra.  
Attacco tubo rame, plastica e multistrato.

*Chromium-plated left angle radiator valve with thermostatic option. Connection for copper, plastic and multilayer pipe.*

<b>305</b>	<b>f</b>	<b>⊗</b>	<b>⊗</b>
30538 <b>ST</b>	3/8"	10	50
30512 <b>ST</b>	1/2"	10	50
30538	3/8"	10	50
30512	1/2"	10	50



Detentore cromato ad angolo, versione destra.  
Attacco tubo rame, plastica e multistrato.

*Chromium-plated right angle lockshield. Connection for copper, plastic and multilayer pipe.*

<b>115</b>	<b>f</b>	<b>⊗</b>	<b>⊗</b>
11538 <b>ST</b>	3/8"	10	50
11512 <b>ST</b>	1/2"	10	50
11538	3/8"	10	50
11512	1/2"	10	50



Detentore cromato ad angolo, versione sinistra.  
Attacco tubo rame, plastica e multistrato.

*Chromium-plated left angle lockshield. Connection for copper, plastic and multilayer pipe.*

<b>116</b>	<b>f</b>	<b>⊗</b>	<b>⊗</b>
11638 <b>ST</b>	3/8"	10	50
11612 <b>ST</b>	1/2"	10	50
11638	3/8"	10	50
11612	1/2"	10	50



Valvola termostattizzabile cromata ad angolo, versione destra.  
Attacco tubo rame, plastica e multistrato.

*Chromium-plated right angle radiator valve with thermostatic option. Connection for copper, plastic and multilayer pipe.*

<b>306</b>	<b>f</b>	<b>⊗</b>	<b>⊗</b>
30638 <b>ST</b>	3/8"	10	50
30612 <b>ST</b>	1/2"	10	50
30638	3/8"	10	50
30612	1/2"	10	50



Raccordo eccentrico cromato  
*Chromium-plated eccentric fitting*

<b>730</b>	<b>f</b>	<b>⊗</b>
7303810	3/8"x 3/8" - 10	10
7303820	3/8"x 3/8" - 20	10
7303830	3/8"x 3/8" - 30	10
7303840	3/8"x 3/8" - 40	10
7303850	3/8"x 3/8" - 50	10
7303860	3/8"x 3/8" - 60	10
7301210	1/2"x 1/2" - 10	10
7301220	1/2"x 1/2" - 20	10
7301230	1/2"x 1/2" - 30	10
7301240	1/2"x 1/2" - 40	10
7301250	1/2"x 1/2" - 50	10
7301260	1/2"x 1/2" - 60	10



Valvola termostattizzabile cromata ad angolo, versione sinistra.  
 Attacco tubo ferro.

*Chromium-plated left angle radiator valve with thermostatic option. Connection for iron pipe.*

<b>325</b>			
32512 <b>ST</b>	1/2"	10	50
32512	1/2"	10	50



Detentore cromato ad angolo, versione destra.  
 Attacco tubo ferro.

*Chromium-plated right angle lockshield. Connection for iron pipe.*

<b>215</b>			
21512 <b>ST</b>	1/2"	10	50
21512	1/2"	10	50



Detentore cromato ad angolo, versione sinistra.  
 Attacco tubo ferro.

*Chromium-plated left angle lockshield. Connection for iron pipe.*

<b>216</b>			
21612 <b>ST</b>	1/2"	10	50
21612	1/2"	10	50



Valvola termostattizzabile cromata ad angolo, versione destra.  
 Attacco tubo ferro.

*Chromium-plated right angle radiator valve with thermostatic option. Connection for iron pipe.*

<b>326</b>			
32612 <b>ST</b>	1/2"	10	50
32612	1/2"	10	50

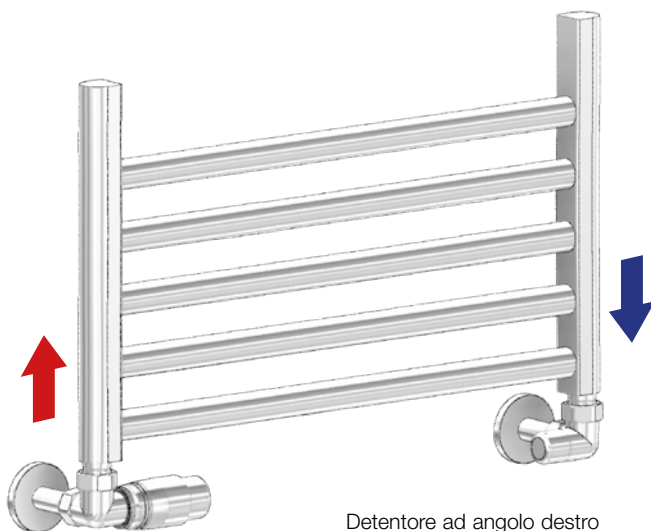

Valvola ad angolo sinistra  
 Left angle valve

Detentore ad angolo destro  
 Right angle lockshield

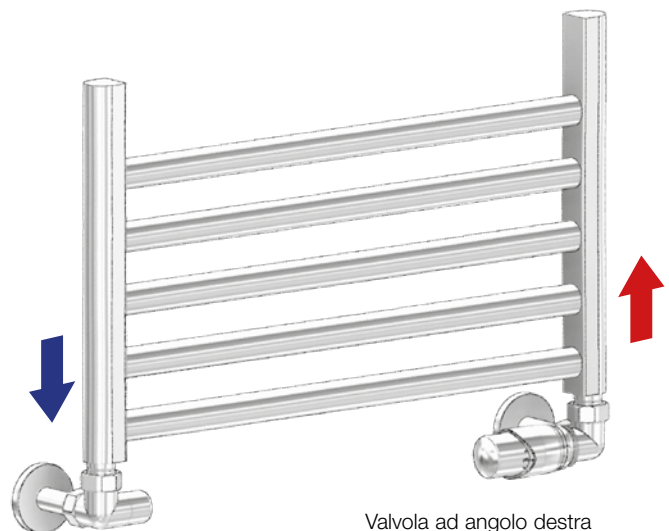

Detentore ad angolo sinistro  
 Left angle lockshield

Valvola ad angolo destra  
 Right angle valve



Valvola termostattizzabile cromata a comando orizzontale.  
 Attacco tubo rame, plastica e multistrato.  
*Chromium-plated valve with thermostatic option and horizontal control. Connection for copper, plastic and multilayer pipe.*

<b>304</b>	<b>f</b>	<b>⊗</b>	<b>⊗</b>
30438 <b>ST</b>	3/8"	10	50
30412 <b>ST</b>	1/2"	10	50
30438	3/8"	10	50
30412	1/2"	10	50



Detentore cromato a comando orizzontale.  
 Attacco tubo rame, plastica e multistrato.  
*Chromium-plated lockshield with horizontal control. Connection for copper, plastic and multilayer pipe.*

<b>104</b>	<b>f</b>	<b>⊗</b>	<b>⊗</b>
10438 <b>ST</b>	3/8"	10	50
10412 <b>ST</b>	1/2"	10	50
10438	3/8"	10	50
10412	1/2"	10	50





Valvola a squadra cromata termostattizzabile con preregolazione.  
 Attacco tubo rame, plastica e multistrato.

*Chromium-plated presetting angle valve with thermostatic option.  
 Connection for copper, plastic and multilayer pipe*

<b>350</b>			
35038 <b>ST</b>	3/8"	10	50
35012 <b>ST</b>	1/2"	10	50
35038	3/8"	10	50
35012	1/2"	10	50



Valvola a squadra cromata termostattizzabile con preregolazione.  
 Attacco tubo ferro.

*Chromium-plated presetting angle valve with thermostatic option.  
 Connection for iron pipe.*

<b>352</b>			
35238 <b>ST</b>	3/8"	10	50
35212 <b>ST</b>	1/2"	10	50
35238	3/8"	10	50
35212	1/2"	10	50
35234	3/4"	10	50



Valvola diritta cromata termostattizzabile con preregolazione.  
 Attacco tubo rame, plastica e multistrato.

*Chromium-plated presetting straight valve with thermostatic option.  
 Connection for copper, plastic and multilayer pipe.*

<b>351</b>			
35138 <b>ST</b>	3/8"	10	50
35112 <b>ST</b>	1/2"	10	50
35138	3/8"	10	50
35112	1/2"	10	50



Valvola diritta cromata termostattizzabile con preregolazione.  
 Attacco tubo ferro.

*Chromium-plated presetting straight valve with thermostatic option.  
 Connection for iron pipe*

<b>353</b>			
35338 <b>ST</b>	3/8"	10	50
35312 <b>ST</b>	1/2"	10	50
35338	3/8"	10	50
35312	1/2"	10	50
35334	3/4"	10	50

**PRESETTING**

Le valvole termostattizzabili con preregolazione consentono il bilanciamento dell'impianto.  
 Ruotando la vite del premiasta si regola la portata d'acqua al radiatore.  
*Presetting valves, with thermostatic option, allow the balance of the system.  
 Turning the screw of the press rod you can regulate the water flow into the radiator.*





Valvola manuale a squadra cromata.  
 Attacco tubo rame, plastica e multistrato.  
 Manual chromium-plated angle radiator valve.  
 Connection for copper, plastic and multilayer pipe.

50	f	×	⊗
5038ST	3/8"	10	50
5012ST	1/2"	10	50
5038	3/8"	10	50
5012	1/2"	10	50



Detentore a squadra cromato.  
 Attacco tubo rame, plastica e multistrato.  
 Chromium-plated angle lockshield.  
 Connection for copper, plastic and multilayer pipe.

51	f	×	⊗
5138ST	3/8"	10	50
5112ST	1/2"	10	50
5138	3/8"	10	50
5112	1/2"	10	50



Valvola manuale a squadra cromata.  
 Attacco tubo rame, plastica e multistrato.  
 Manual chromium-plated angle radiator valve.  
 Connection for copper, plastic and multilayer pipe.

100	f	×	⊗
10038ST	3/8"	10	50
10012ST	1/2"	10	50
10038	3/8"	10	50
10012	1/2"	10	50



Detentore a squadra cromato.  
 Attacco tubo rame, plastica e multistrato.  
 Chromium-plated angle lockshield.  
 Connection for copper, plastic and multilayer pipe.

110	f	×	⊗
11038ST	3/8"	10	50
11012ST	1/2"	10	50
11038	3/8"	10	50
11012	1/2"	10	50



Valvola manuale diritta cromata.  
 Attacco tubo rame, plastica e multistrato.  
 Manual chromium-plated straight radiator valve.  
 Connection for copper, plastic and multilayer pipe.

120	f	×	⊗
12038ST	3/8"	10	50
12012ST	1/2"	10	50
12038	3/8"	10	50
12012	1/2"	10	50



Detentore diritto cromato.  
 Attacco tubo rame, plastica e multistrato.  
 Chromium-plated straight lockshield.  
 Connection for copper, plastic and multilayer pipe.

130	f	×	⊗
13038ST	3/8"	10	50
13012ST	1/2"	10	50
13038	3/8"	10	50
13012	1/2"	10	50



Valvola manuale a squadra cromata.  
 Attacco tubo ferro.

*Manual chromium-plated angle radiator valve.  
 Connection for iron pipe.*

<b>60</b>	<b>f</b>	<b>⊠</b>	<b>⊞</b>
6012 <b>ST</b>	1/2"	10	50
6012	1/2"	10	50



Detentore a squadra cromato.  
 Attacco tubo ferro.

*Chromium-plated angle lockshield.  
 Connection for iron pipe.*

<b>61</b>	<b>f</b>	<b>⊠</b>	<b>⊞</b>
6112 <b>ST</b>	1/2"	10	50
6112	1/2"	10	50



Valvola manuale a squadra cromata.  
 Attacco tubo ferro.

*Manual chromium-plated angle radiator valve.  
 Connection for iron pipe.*

<b>200</b>	<b>f</b>	<b>⊠</b>	<b>⊞</b>
20038 <b>ST</b>	3/8"	10	50
20012 <b>ST</b>	1/2"	10	50
20038	3/8"	10	50
20012	1/2"	10	50



Detentore a squadra cromato.  
 Attacco tubo ferro.

*Chromium-plated angle lockshield.  
 Connection for iron pipe.*

<b>210</b>	<b>f</b>	<b>⊠</b>	<b>⊞</b>
21038 <b>ST</b>	3/8"	10	50
21012 <b>ST</b>	1/2"	10	50
21038	3/8"	10	50
21012	1/2"	10	50



Valvola manuale diritta cromata.  
 Attacco tubo ferro.

*Manual chromium-plated straight radiator valve.  
 Connection for iron pipe.*

<b>220</b>	<b>f</b>	<b>⊠</b>	<b>⊞</b>
22038 <b>ST</b>	3/8"	10	50
22012 <b>ST</b>	1/2"	10	50
22038	3/8"	10	50
22012	1/2"	10	50



Detentore diritto cromato.  
 Attacco tubo ferro.

*Chromium-plated straight lockshield.  
 Connection for iron pipe.*

<b>230</b>	<b>f</b>	<b>⊠</b>	<b>⊞</b>
23038 <b>ST</b>	3/8"	10	50
23012 <b>ST</b>	1/2"	10	50
23038	3/8"	10	50
23012	1/2"	10	50



Valvola manuale cromata ad angolo versione sinistra.  
Attacco tubo rame, plastica e multistrato.  
Manual chromium-plated left angle radiator valve.  
Connection for copper, plastic and multilayer pipe.

105			
10538ST	3/8"	10	50
10512ST	1/2"	10	50
10538	3/8"	10	50
10512	1/2"	10	50



Detentore cromato ad angolo versione destra.  
Attacco tubo rame, plastica e multistrato.  
Chromium-plated right angle lockshield.  
Connection for copper, plastic and multilayer pipe.

115			
11538ST	3/8"	10	50
11512ST	1/2"	10	50
11538	3/8"	10	50
11512	1/2"	10	50



Detentore cromato ad angolo versione sinistra.  
Attacco tubo rame, plastica e multistrato.  
Chromium-plated left angle lockshield.  
Connection for copper, plastic and multilayer pipe.

116			
11638ST	3/8"	10	50
11612ST	1/2"	10	50
11638	3/8"	10	50
11612	1/2"	10	50



Valvola manuale cromata ad angolo versione destra.  
Attacco tubo rame, plastica e multistrato.  
Manual chromium-plated right angle radiator valve.  
Connection for copper, plastic and multilayer pipe.

106			
10638ST	3/8"	10	50
10612ST	1/2"	10	50
10638	3/8"	10	50
10612	1/2"	10	50



Prolunga cromata filetto 24x19 M/F con ogiva di tenuta.  
Attacco tubo rame, plastica e multistrato.  
Chromium fitting thread 24x19 M/F with seal.  
Connection for copper, plastic and multilayer pipe.

865			
86524	24x19 M/F	30 mm	25

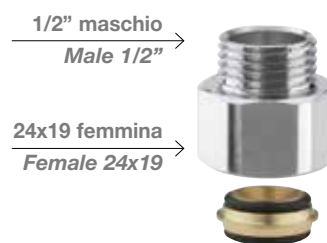

Adattatore cromato da filetto 24x19 ad attacco 1/2" gas maschio  
con ogiva di tenuta.  
Chromium fitting reduction 24x19 for male 1/2" gas connection  
with seal.

867			
86724	24x19 F - 1/2"M	30 mm	25



Valvola manuale cromata ad angolo versione sinistra.  
 Attacco tubo ferro.

*Manual chromium-plated left angle radiator valve.  
 Connection for iron pipe.*

<b>205</b>			
20512 <b>ST</b>	1/2"	10	50
20512	1/2"	10	50



Detentore cromato ad angolo versione destra.  
 Attacco tubo ferro.

*Chromium-plated right angle lockshield.  
 Connection for iron pipe.*

<b>215</b>			
21512 <b>ST</b>	1/2"	10	50
21512	1/2"	10	50



Detentore cromato ad angolo versione sinistra.  
 Attacco tubo ferro.

*Chromium-plated left angle lockshield.  
 Connection for iron pipe.*

<b>216</b>			
21612 <b>ST</b>	1/2"	10	50
21612	1/2"	10	50



Valvola manuale cromata ad angolo versione destra.  
 Attacco tubo ferro.

*Manual chromium-plated right angle radiator valve.  
 Connection for iron pipe.*

<b>206</b>			
20612 <b>ST</b>	1/2"	10	50
20612	1/2"	10	50

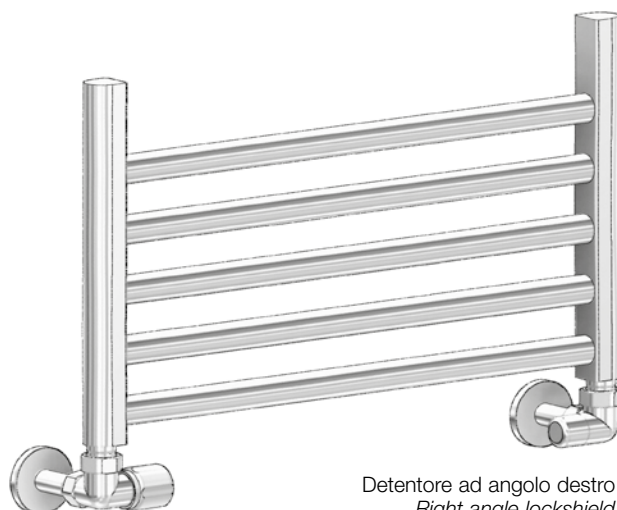

Detentore ad angolo destro  
*Right angle lockshield*

Valvola ad angolo sinistra  
*Left angle valve*

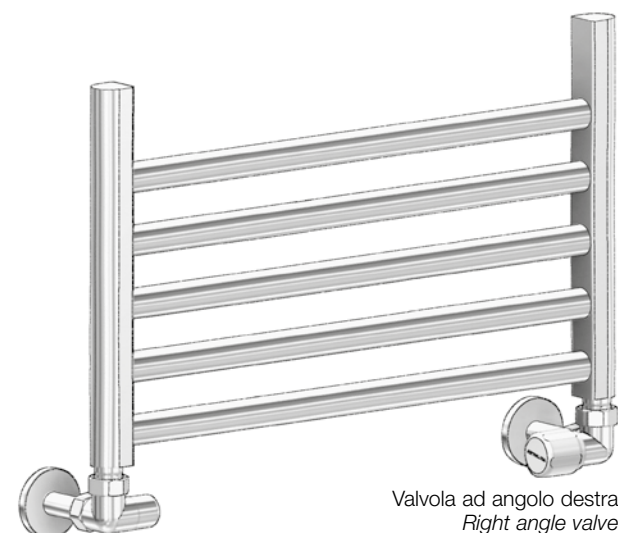

Valvola ad angolo destra  
*Right angle valve*

Detentore ad angolo sinistro  
*Left angle lockshield*

termostattizzabile  
thermostatic option



Valvola MONOTUBO termostattizzabile completa di sonda.  
Interasse derivazioni 38 mm. Derivazioni 24x19.

SINGLE pipe radiator valve with thermostatic option and probe,  
connections 24x19. Center distance connections 38 mm.

4004			
400412	1/2"	5	25
400434	3/4"	5	25
40041D	1" DX	5	25
40041S	1" SX	5	25

termostattizzabile  
thermostatic option



Valvola BITUBO termostattizzabile completa di sonda.  
Interasse derivazioni 38 mm. Derivazioni 24x19.

DOUBLE pipe radiator valve with thermostatic option and probe,  
connections 24x19. Center distance connections 38 mm.

4005			
400512	1/2"	5	25
400534	3/4"	5	25
40051D	1" DX	5	25
40051S	1" SX	5	25

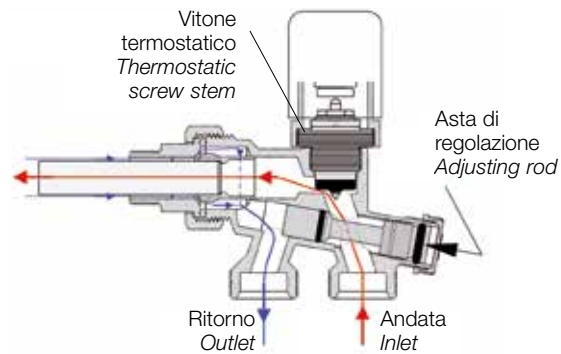
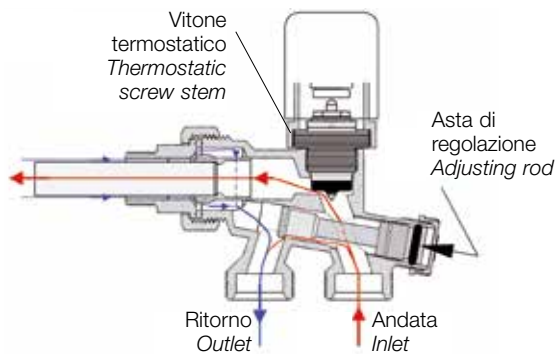

Raccordo cromato per valvole monotubo/bitubo  
serie 4004/4005.

Chromium-plated fitting for single or double pipe radiator valves  
items 4004/4005.

417		
41712	1/2"	10
41734	3/4"	10



Calotta cromata per valvole monotubo/bitubo serie 4004/4005.

Chromium-plated brass nut for single or double pipe radiator  
valves items 4004/4005.

416		
4161	1"	10



Raccordo cromato per valvole monotubo/bitubo  
serie 4004/4005.

Chromium-plated fitting for single or double pipe radiator valves  
items 4004/4005.

4171		
4171D	1"DX	10
4171S	1"SX	10



Sonda in PVC per valvole monotubo/bitubo serie 4004/4005.

PVC probe for single or double pipe radiator valves items  
4004/4005.

418		
41812	1/2"	10
41834	3/4"	10
4181	1"	10

**Sistema intercambiabile** per tubo rame, plastica e multistrato. **Interchangeable system** for copper, plastic and multilayer pipe.

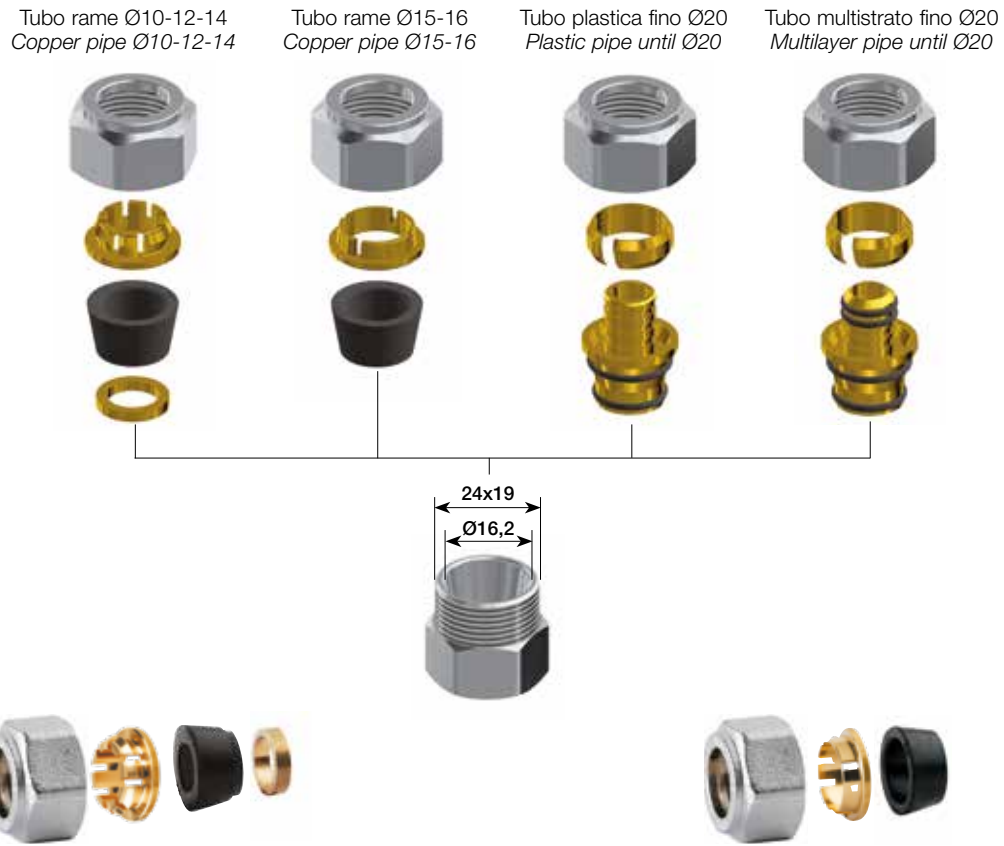

Raccordo a compressione per tubo rame, monocono in gomma, calotta filetto 24x19 cromata.  
*Compression fitting connection for copper pipe. Rubber monocone and chromium-plated brass nut thread 24x19.*

<b>720C</b>			
72010C	Ø10	50	250
72012C	Ø12	50	250
72014C	Ø14	50	250

Raccordo a compressione per tubo rame, monocono in gomma, calotta filetto 24x19 cromata.  
*Compression fitting connection for copper pipe. Rubber monocone and chromium-plated brass nut thread 24x19.*

<b>721C</b>			
72115C	Ø15	50	250
72116C	Ø16	50	250



Raccordo per tubo plastica, calotta filetto 24x19 cromata.  
*Fitting for plastic pipe. Chromium-plated brass nut thread 24x19.*

<b>751C</b>			
75112C	12 x 2	50	250
75115C	15 x 2,5	50	250
75116C	16 x 2	50	250
75117C	17 x 2	50	250
75118C	18 x 2,5	50	250
75120C	20 x 2	50	250
75125C	20 x 2,5	50	250

Raccordo per tubo multistrato, calotta filetto 24x19 cromata.  
*Fitting for multilayer pipe. Chromium-plated brass nut thread 24x19.*

<b>753C</b>			
75314C	14 x 2	50	250
75315C	15 x 2,5	50	250
75316C	16 x 2	50	250
753162C	16 x 2,25	50	250
753166C	16,2 x 2,6	50	250
753168C	16,8 x 2,5	50	250
75317C	17 x 2	50	250
753177C	17 x 2,7	50	250
75318C	18 x 2	50	250
75320C	20 x 2	50	250
753202C	20 x 2,25	50	250
75325C	20 x 2,5	50	250
75329C	20 x 2,9	50	250



Calotta cromata filetto 24x19  
esagono 27 mm.

*Chromium-plated brass nut thread 24x19.*

<b>321C</b>	<b>f</b>	<b>☒</b>
32116C	Ø16	50
32118C	Ø18	50
32120C	Ø20	50



Calotta cromata.

*Chromium-plated brass nut.*

<b>322</b>	<b>f</b>	<b>☒</b>
32212	1/2"	10
32234	3/4"	10



Codolo di riduzione da 1/2" a 3/8" per  
valvole e detentori con anello O-ring.

*Reduction fitting 1/2"-3/8" for valves and  
lockshields, with O-ring.*

<b>328ST</b>	<b>f</b>	<b>☒</b>
32838ST	1/2" x 3/8"	10



Codolo di riduzione da 1/2" a 3/8" per  
valvole e detentori con anello O-ring e  
gomma di tenuta.

*Reduction fitting 1/2"-3/8" for valves and  
lockshields with rubber sealing and O-ring.*

<b>328G</b>	<b>f</b>	<b>☒</b>
32838G	1/2" x 3/8"	10



Codolo cromato standard per valvole e  
detentori con anello O-ring.

*Chromium-plated fitting for valves and  
lockshields with O-ring.*

<b>323ST</b>	<b>f</b>	<b>☒</b>
32338ST	3/8"	10
32312ST	1/2"	10



Codolo cromato per valvole e detentori con  
anello O-ring e gomma di tenuta.

*Chromium-plated fitting for valves and  
lockshields, with rubber sealing and O-ring.*

<b>323G</b>	<b>f</b>	<b>☒</b>
32338G	3/8"	10
32312G	1/2"	10



Anello O-ring per codolo.

*O-ring for fitting.*

<b>3260</b>	<b>f</b>	<b>☒</b>
326038	3/8"	50
326012	1/2"	50



Chiave per codolo valvole e detentori.

*Spanner for valve and lockshield fittings.*

<b>638</b>	<b>f</b>	<b>☒</b>
63838	3/8"	10
63812	1/2"	10



Chiave poligonale per calotte esagono  
24 e 27 mm.

*Polygon spanner for 24 and 27 mm hexagon  
nuts.*

<b>637</b>	<b>f</b>	<b>☒</b>
637	24-27	1



Manopola in ABS bianco per valvole.

*White ABS handwheel for valves.*

<b>3150BB</b>	<b>f</b>	<b>☒</b>
3150BB	-	10



Manopola in ABS bianco per valvole  
termostattizzabili.

*White ABS handwheel for valves with  
thermostatic option.*

<b>3160BB</b>	<b>f</b>	<b>☒</b>
3160BB	-	10



Cappuccio manuale in ABS bianco per  
valvole termostatiche.

*White ABS manual cap for valves with  
thermostatic option.*

<b>3170</b>	<b>f</b>	<b>☒</b>
3170	-	10





Cappuccio in ABS per detentori.  
*White ABS cap for lockshields.*

<b>320BB</b>		
320BB	-	10



Piastra coprimuro e copritubo bianca.  
*White wall cover with pipe cover.*

<b>318BB</b>		
318BB	Ø10÷18	50



Piastra coprimuro e copritubo cromata.  
*Chromium-plated wall cover with pipe cover.*

<b>318LL</b>		
318LL	Ø10÷18	50



Piastrina coprimuro singola.  
*Universal wall cover.*

<b>318U</b>		
318U	Ø10÷22	100



Piastrina coprimuro per valvole monotubo/  
bitubo. Interasse regolabile 36÷48 mm.  
*Wall cover for single or double pipe radiator  
valve with adjustable center distance  
36÷48 mm.*

<b>412U</b>		
412U	Ø10÷22	25

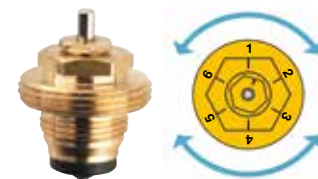

Vitone per valvole termostattabili con  
preregolazione serie **350**.

*Screw stem for presetting valves with  
thermostatic option items **350**.*

<b>3179</b>		
3179	20/19	10



Vitone per valvole termostattabili serie **250**.  
*Screw stem for valves with thermostatic  
option items **250**.*

<b>3177</b>		
3177	19/19	10



Vitone per valvole termostattabili serie **300**.  
*Screw stem for valves with thermostatic  
option items **300**.*

<b>3175</b>		
3175	20/19	10



Premiasta e O-ring di tenuta per vitone  
termostatico art. **3175 / 3177**.  
*Press rod with O-ring for thermostatic screw  
stem, items **3175 / 3177**.*

<b>3176</b>		
3176	ES15	10



Vitone per valvole serie **100 / 200**.  
*Screw stem for valves items **100 / 200**.*

<b>1175</b>		
1175	20/19	10



Vitone per valvole serie **50 / 60**.  
*Screw stem for valves items **50 / 60**.*

<b>1176</b>		
1176	19/19	10



Vitone per detentori serie **110 / 210**.  
*Screw stem for lockshields items **110 / 210**.*

<b>1177</b>		
1177	20/19	10



## Valvole sfogo aria / sicurezza

Valvole sfogo aria	102
Valvole di sicurezza	104
Riduttori di pressione	105
Filtri autopulenti e defangatori	106
Termomanometri	109
Valvole di zona motorizzate	110
Miscelatori termostatici	111
Componenti per impianti solari	112

## *Air vent / security valves*

<i>Air vent valves</i>	<i>102</i>
<i>Safety valves</i>	<i>104</i>
<i>Pressure reducing</i>	<i>105</i>
<i>Self cleaning filters and dirt separators</i>	<i>106</i>
<i>Thermometrical pressure gauges</i>	<i>109</i>
<i>Zone valves with motors</i>	<i>110</i>
<i>Thermostatic mixers</i>	<i>111</i>
<i>Solar panel components</i>	<i>112</i>





Valvola sfogo aria automatica in ottone giallo (h.62).  
Automatic air vent valve of yellow brass (h.62).

Valvola sfogo aria automatica in ottone cromato (h.62).  
Automatic air vent valve of chromium-plated brass (h.62).

<b>504</b>			
50438	3/8"	10	100
50412	1/2"	10	100

<b>504CR</b>			
50438CR	3/8"	10	100
50412CR	1/2"	10	100



Valvola sfogo aria automatica in ottone giallo (h.50).  
Automatic air vent valve of yellow brass (h.50).

Valvola sfogo aria automatica in ottone cromato (h.50).  
Automatic air vent valve of chromium-plated brass (h.50).

<b>505</b>			
50538	3/8"	10	100
50512	1/2"	10	100

<b>505CR</b>			
50538CR	3/8"	10	100
50512CR	1/2"	10	100



Valvola sfogo aria automatica con sfiato laterale.  
Automatic air vent valve with side discharging.

Valvola sfogo aria automatica con attacco laterale.  
Automatic air vent valve with side connection.

<b>506</b>			
Gialla - Yellow			
50638	3/8"	10	100
50612	1/2"	10	100
Nichelata - Nickel-plated			
50638N	3/8"	10	100
50612N	1/2"	10	100

<b>507</b>			
Gialla - Yellow			
50738	3/8"	10	50
50712	1/2"	10	50
Nichelata - Nickel-plated			
50738N	3/8"	10	50
50712N	1/2"	10	50



Valvola di sfogo aria manopola Hostaform.  
Filetto a tenuta Teflon.  
*Air vent valve with Hostaform handwheel. Teflon on thread.*

<b>500</b>			
50014	1/4"	50	500
50038	3/8"	50	500



Valvola di sfogo aria manopola Hostaform.  
*Air vent valve with Hostaform handwheel.*

<b>501</b>			
50114	1/4"	50	500
50138	3/8"	50	500
50112	1/2"	50	500



Valvola sfogo aria manuale con O-ring.  
*Manual air vent valve with O-ring.*

<b>502</b>			
50214	1/4"	50	500
50238	3/8"	50	500



Valvola sfogo aria con possibilità di rotazione dello scarico.  
Filetto tenuta O-ring.  
*Air vent valve for radiators with adjustable drain, O-ring seal on thread.*

<b>503</b>			
50312	1/2"	25	250



Valvola sfogo aria automatica.  
*Automatic air vent valve.*

<b>508</b>			
50838	3/8"	10	50
50812	1/2"	10	50



Valvola sfogo aria cromata con possibilità di rotazione dello scarico. Filetto tenuta O-ring.  
*Chromium-plated air vent valve for radiators with adjustable drain, O-ring seal on thread.*

<b>503CR</b>			
50312CR	1/2"	25	250



Valvola di sicurezza a membrana M/F.  
Diaphragm, safety valve M/F.

<b>565</b>	<b>f</b>	<b>⊗</b>
56512 BAR 1,5	1/2" M/F	10
56512 BAR 3	1/2" M/F	10
56512 BAR 4	1/2" M/F	10
56512 BAR 6	1/2" M/F	10
56512 BAR 7	1/2" M/F	10



Valvola di sicurezza a membrana F/F.  
Diaphragm, safety valve F/F.

<b>565F</b>	<b>f</b>	<b>⊗</b>
56512F BAR 1,5	1/2" F/F	10
56512F BAR 3	1/2" F/F	10
56512F BAR 4	1/2" F/F	10
56512F BAR 6	1/2" F/F	10
56512F BAR 7	1/2" F/F	10



Gruppo di alimentazione M/F con manometro Ø63.  
Automatic supply valve M/F with gauge Ø63.

<b>570</b>	<b>f</b>	<b>⊗</b>	<b>⊗</b>
57012	1/2" M/F	1	20



Gruppo di alimentazione M/F.  
Automatic supply valve M/F.

<b>571</b>	<b>f</b>	<b>⊗</b>	<b>⊗</b>
57112	1/2" M/F	1	20



Gruppo di alimentazione M/F preregolabile con manometro Ø63.  
Presetting supply valve M/F with pressure gauge Ø63.

<b>568</b>	<b>f</b>	<b>⊗</b>	<b>⊗</b>
56812	1/2" M/F	1	20



Gruppo di alimentazione M/F preregolabile.  
Presetting supply valve M/F.

<b>569</b>	<b>f</b>	<b>⊗</b>	<b>⊗</b>
56912	1/2" M/F	1	20



Riduttore di pressione (PN15) con attacchi F/F nichelato con attacco manometro.

*Nickel pressure reducing (PN15) with F/F and gauge connection.*

<b>572</b>	<b>f</b>	<b>⊗</b>	<b>⊗</b>
57212	1/2"	1	20
57234	3/4"	1	20



Riduttore di pressione (PN 25) con raccordi F/F - sede Inox.

*Pressure reducing (PN 25) with F/F fittings and Inox seat.*

<b>573</b>	<b>f</b>	<b>⊗</b>	<b>⊗</b>
57312	1/2"	1	20
57334	3/4"	1	20
5731	1"	1	5



Riduttore di pressione (PN 25) con raccordi M/M - sede Inox.

*Pressure reducing (PN 25) with M/M fittings and Inox seat.*

<b>574</b>	<b>f</b>	<b>⊗</b>	<b>⊗</b>
57412	1/2"	1	20
57434	3/4"	1	20
5741	1"	1	5



Riduttore di pressione (PN 25) con attacchi F/F - sede Inox.

*Pressure reducing (PN 25) with F/F connections and Inox seat.*

<b>575</b>	<b>f</b>	<b>⊗</b>	<b>⊗</b>
57512	1/2"	1	20
57534	3/4"	1	20
5751	1"	1	5



Riduttore di pressione (PN 25) con raccordi M/M - sede Inox. Manometri in entrata e in uscita.

*Pressure reducing (PN 25) with fittings M/M and Inox seat. Entry and exit pressure gauge.*

<b>579</b>	<b>f</b>	<b>⊗</b>	<b>⊗</b>
57912	1/2"	1	5
57934	3/4"	1	5



Riduttore di pressione (PN25) prerogolabile con raccordi F/F oppure M/M - sede inox.



*Presetting pressure reducing (PN 25) with F/F or M/M connections and Inox seat.*

<b>566</b>	<b>f</b>	<b>⊗</b>	<b>⊗</b>
56612F	1/2" con raccordi F/F	1	10
56634F	3/4" con raccordi F/F	1	5
5661F	1" con raccordi F/F	1	5
56612M	1/2" con raccordi M/M	1	10
56634M	3/4" con raccordi M/M	1	5
5661M	1" con raccordi M/M	1	5





Filtro autopulente (PN25) con manometro, cartuccia inox filtrazione 100 Micron oppure 300 Micron.

*Self cleaning filter (PN25) with gauge, 100 or 300 Micron - inox cartridge*

<b>590</b>			
590121	1/2"-3/4"	100 Micron	1
590123	1/2"-3/4"	300 Micron	1

Filtro autopulente (PN25) con cartuccia inox filtrazione 100 Micron oppure 300 Micron.

*Self cleaning filter (PN25) 100 or 300 Micron - inox cartridge*

<b>591</b>			
591121	1/2"-3/4"	100 Micron	1
591123	1/2"-3/4"	300 Micron	1

4 possibilità di collegamento, grazie al sistema 4 in 1:  
*4 connection options, thanks to the 4-in-1 system:*



1/2" M con bocchettone  
*1/2" M with fitting*



3/4" F con bocchettone girevole  
*3/4" F changed the side of the fitting*



Filetto interno 1/2"F  
*Inside thread 1/2"F*



Filetto esteso 3/4"M  
*Outside thread 3/4"M*

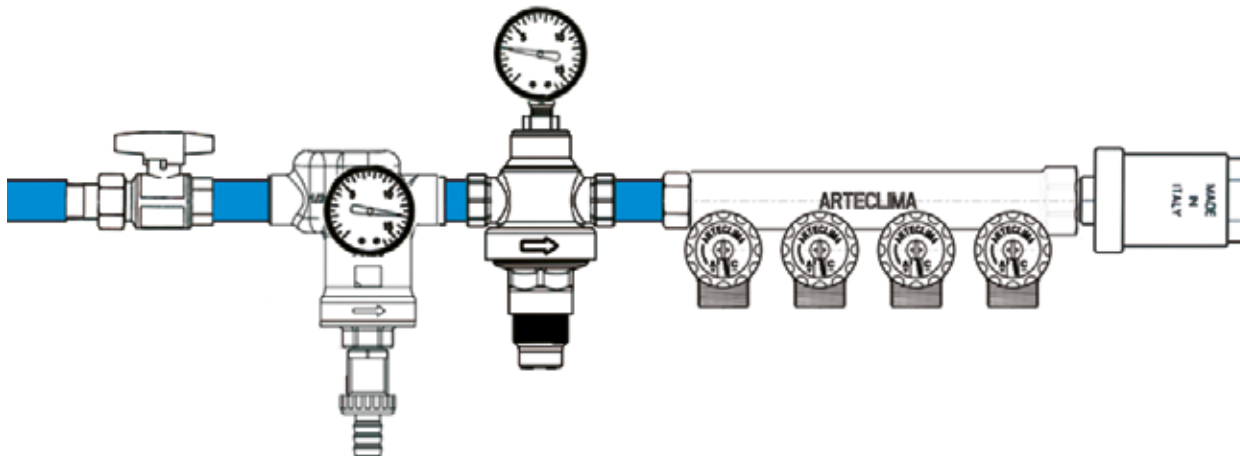





**magnetico**  
magnetic option

Filtro Y magnetico.  
Magnetic Y filter.

<b>594</b>			
59434	3/4"	1	20
5941	1"	1	20



Filtro Y.  
Y filter.

<b>593</b>			
59312	1/2"	1	20
59334	3/4"	1	20
5931	1"	1	20
593114	1"1/4	1	20
593112	1" 1/2	1	20



Valvola anti colpo d'ariete.  
Stopshock valve.

<b>592</b>			
59212	1/2"	1	20



**magnetico**  
magnetic option

Filtro defangatore magnetico sottocaldaia compatto.  
Underboiler magnetic compact dirt separator.

<b>595</b>			
59534	3/4"	1	5

Filtrazione magnetica  
Magnetic filtration



Filtrazione meccanica  
Mechanical filtration





Filtro autopulente F/F, (PN 25) filtrazione 100 micron, due manometri e rubinetto di scarico.

*Self cleaning filter F/F (PN 25) with 100 micron cartridge, two gauge and drain water tap.*

<b>577</b>			
57712	1/2"	100 micron	1
57734	3/4"	100 micron	1
5771	1"	100 micron	1
577114	1"1/4	100 micron	1
577112	1"1/2	100 micron	1



Filtro autopulente F/F, (PN 25) filtrazione 300 micron, due manometri e rubinetto di scarico.

*Self cleaning filter F/F (PN 25) with 300 micron cartridge, two gauge and drain water tap.*

<b>578</b>			
57812	1/2"	300 micron	1
57834	3/4"	300 micron	1
5781	1"	300 micron	1
578114	1"1/4	300 micron	1
578112	1"1/2	300 micron	1



**magnetico**  
magnetic option

Filtro defangatore F/F (PN15) magnetico.

*Magnetic dirt separator F/F (PN15).*

<b>589 MAGNETICO</b>		
58934	3/4"	1
5891	1"	1
589114	1"1/4	1
589112	1"1/2	1

Filtro defangatore F/F (PN10) standard.

*Standard dirt separator F/F (PN10).*

<b>588 STANDARD</b>		
58834	3/4"	1
5881	1"	1
588114	1"1/4	1
588112	1"1/2	1



**magnetico**  
magnetic option

Filtro defangatore F/F (PN15) magnetico con valvola sfogo aria.

*Magnetic dirt separator F/F (PN15) with automatic air vent valve.*

<b>589V MAGNETICO</b>		
589V34	3/4"	1
589V1	1"	1
589V114	1"1/4	1
589V112	1"1/2	1

Filtro defangatore F/F (PN10) standard con valvola sfogo aria.

*Standard dirt separator F/F (PN10) with automatic air vent valve.*

<b>588V STANDARD</b>		
588V34	3/4"	1
588V1	1"	1
588V114	1"1/4	1
588V112	1"1/2	1



Termomanometro Ø 80 mm. Attacco 1/4" posteriore.  
*Thermogauge 1/4", Ø mm 80, back connection.*

<b>576TP</b>			
5764TP	0÷4 bar	10	50
5766TP	0÷6 bar	10	50
57610TP	0÷10bar	10	50



Termomanometro Ø 80 mm. Attacco 1/4" radiale.  
*Thermogauge 1/4", Ø mm 80, radial connection.*

<b>576TR</b>			
5764TR	0÷4 bar	10	50
5766TR	0÷6 bar	10	50
57610TR	0÷10bar	10	50



Manometro Ø 63 mm. Attacco 1/4" radiale.  
*Pressure gauge 1/4", Ø mm 63, radial connection.*

<b>576BR</b>			
5764BR	0÷4 bar	10	50
5766BR	0÷6 bar	10	50
57610BR	0÷10bar	10	50



Manometro Ø 63 mm. Attacco 1/4" posteriore.  
*Pressure gauge 1/4", Ø mm 63, back connection.*

<b>576BP</b>			
5764BP	0÷4 bar	10	50
5766BP	0÷6 bar	10	50
57610BP	0÷10bar	10	50



Manometro Ø 50 mm. Attacco 1/4" G posteriore o radiale.  
*Pressure gauge 1/4", Ø mm 50, gas back or radial connection.*

<b>576</b>			
5764P	0÷4 bar	10	50
5766P	0÷6 bar	10	50
57610P	0÷10bar	10	50
5764R	0÷4 bar	10	50
5766R	0÷6 bar	10	50
57610R	0÷10bar	10	50



Termometro bimetallico Ø 40 mm - scala 0°÷80°C.  
*Bimetallic thermometer Ø mm 40 - range from 0° to 80°C.*

<b>614</b>		
614	-	10
61412	1/2G	10



Cartuccia filtro di ricambio 100 micron.  
*Spare filter cartridge from 100 micron.*

<b>577R</b>			
577R34	1/2"-3/4"	100 micron	1
577R1	1"-1"1/4	100 micron	1
577R12	1"1/2	100 micron	1

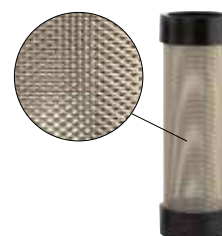

Cartuccia filtro di ricambio 300 micron.  
*Spare filter cartridge from 300 micron.*

<b>578R</b>			
578R34	1/2"-3/4"	300 micron	1
578R1	1"-1"1/4	300 micron	1
578R12	1"1/2	300 micron	1



Valvola di zona tre vie F/F a passaggio totale con servocomando.

Zone valve with three ways F/F, total passage and motor.

<b>580S</b>	<b>f</b>	<b>⊗</b>	<b>⊗</b>
58034S	3/4"	1	5
5801S	1"	1	5
580114S	1"1/4	1	5



Valvola di zona due vie M/F a passaggio totale con servocomando.

Zone valve with two ways M/F, total passage and motor.

<b>581S</b>	<b>f</b>	<b>⊗</b>	<b>⊗</b>
58112S	1/2"	1	5
58134S	3/4"	1	5
5811S	1"	1	5
58114S	1"1/4	1	5



Valvola di zona tre vie F/F a passaggio totale.

Zone valve with three ways F/F, total passage.

<b>580</b>	<b>f</b>	<b>⊗</b>	<b>⊗</b>
58034	3/4"	1	5
5801	1"	1	5
580114	1"1/4	1	5



Valvola di zona due vie M/F a passaggio totale.

Zone valve with two ways M/F, total passage.

<b>581</b>	<b>f</b>	<b>⊗</b>	<b>⊗</b>
58112	1/2"	1	5
58134	3/4"	1	5
5811	1"	1	5
581114	1"1/4	1	5



Servocomando bidirezionale per valvole di zona a tre vie con micro ausiliario.

Bidirectional motor for zone valves three ways with auxiliary micro switch.

<b>583</b>	<b>f</b>	<b>⊗</b>	<b>⊗</b>
58324	3 vie	1	5



Servocomando unidirezionale per valvole di zona a due vie con micro ausiliario.

One-way motor for zone valves two ways with auxiliary micro switch.

<b>582</b>	<b>f</b>	<b>⊗</b>	<b>⊗</b>
58223	2 vie	1	5

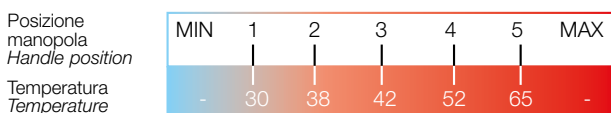

Miscelatore termostatico.  
Temperatura massima d'ingresso 85°C.

*Thermostatic mixer.  
Maximum entry temperature 85°C.*

<b>550</b>	<input checked="" type="checkbox"/>	<input checked="" type="checkbox"/>
55012	1/2"	1
55034	3/4"	1
5501	1"	1
550114	1"1/4	1
550112	1"1/2	1



Pre-miscelatore termostatico MINI, pre-tarato in fabbrica a 40°C.  
Funzione anti-scottatura, bloccaggio della temperatura impostata e valvole di non ritorno.

*Mini thermostatic pre-mixer, 40°C factory pre-calibrated, anti-scald function, locking of the set temperature and check valve*

<b>551</b>	<input checked="" type="checkbox"/>	<input checked="" type="checkbox"/>
55112	1/2"	1

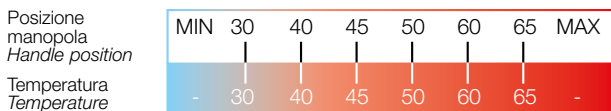

Miscelatore termostatico sottoboiler.  
Temperatura massima d'ingresso 85°C.

*Under boiler thermostatic mixer.  
Maximum entry temperature 85°C.*

<b>560</b>	<input checked="" type="checkbox"/>	<input checked="" type="checkbox"/>
56012	1/2"	1

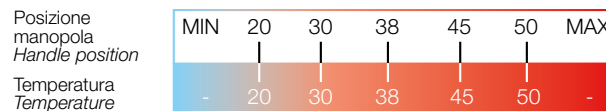

Miscelatore termostatico per acqua calda sanitaria.  
Temperatura massima d'ingresso 85°C.

*Thermostatic mixer for domestic hot water.  
Maximum entry temperature 85°C.*

<b>559</b>	<input checked="" type="checkbox"/>	<input checked="" type="checkbox"/>
5591	1"	1



Valvola di sicurezza attacchi F/F per impianti solari.  
Campo di temperatura:  $-30^{\circ} \div 160^{\circ}\text{C}$ .  
Percentuale di glicole: max 50%.

*Safety valve F/F for solar panel systems.*  
*Temperature range:  $-30^{\circ} \div 160^{\circ}\text{C}$ .*  
*Glycol percentage: max 50%.*

<b>567</b>	<b>f</b>	<b>⊗</b>
567 BAR 2,5	1/2" x 3/4"	10
567 BAR 3	1/2" x 3/4"	10
567 BAR 4	1/2" x 3/4"	10
567 BAR 6	1/2" x 3/4"	10
567 BAR 8	1/2" x 3/4"	10
567 BAR 10	1/2" x 3/4"	10



Valvola automatica sfogo aria per impianti solari.  
Campo di temperatura:  $-30^{\circ} \div 160^{\circ}\text{C}$ .  
Percentuale di glicole: max 50%.

*Automatic air vent valve for solar panel systems.*  
*Temperature range:  $-30^{\circ} \div 160^{\circ}\text{C}$ .*  
*Glycol percentage: max 50%.*

<b>510</b>	<b>f</b>	<b>⊗</b>
51038	3/8"	10
51012	1/2"	10



**SOLAR**

Posizione  
manopola  
Handle position  
Temperatura  
Temperature

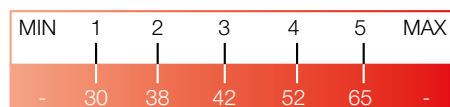

Miscelatore termostatico attacchi F/F per impianti solari.  
Temperatura massima d'ingresso  $100^{\circ}\text{C}$ .

*Thermostatic mixer F/F for solar panel systems.*  
*Maximum entry temperature  $100^{\circ}\text{C}$ .*

<b>555</b>	<b>f</b>	<b>⊗</b>
55512	1/2"	1
55534	3/4"	1
5551	1"	1



**SOLAR**

Posizione  
manopola  
Handle position  
Temperatura  
Temperature

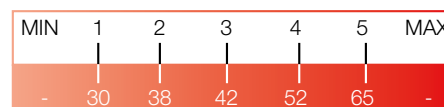

Miscelatore termostatico attacchi M/M per impianti solari.  
Temperatura massima d'ingresso  $100^{\circ}\text{C}$ .



*Thermostatic mixer M/M for solar panel systems.*  
*Maximum entry temperature  $100^{\circ}\text{C}$ .*

<b>556</b>	<b>f</b>	<b>⊗</b>
55612	1/2"	1
55634	3/4"	1
5561	1"	1
556114	1"1/4	1
556112	1"1/2	1



Valvola deviatrice termostatica solare - taratura 45°C.

*Thermostatic solar diverter valve - 45°C calibration*

<b>557</b>		
55734	3/4"	1
5571	1"	1





**SOLAR**

Posizione manopola Handle position	1	2	3	4	5	MAX
Temperatura Temperature	30	38	42	52	65	-

Miscelatore termostatico solare con bocchettoni e valvole di non ritorno.



*Thermostatic solar mixer with fittings and check valves.*

<b>558</b>		
55812	1/2"	1
55834	3/4"	1



Miscelatore termostatico anticondensa.

*Thermostatic mixer for anticondensation.*

<b>552</b>		taratura	
55215	1"	50°C	1
55216	1"	60°C	1
55217	1"	70°C	1
55218	1"	80°C	1

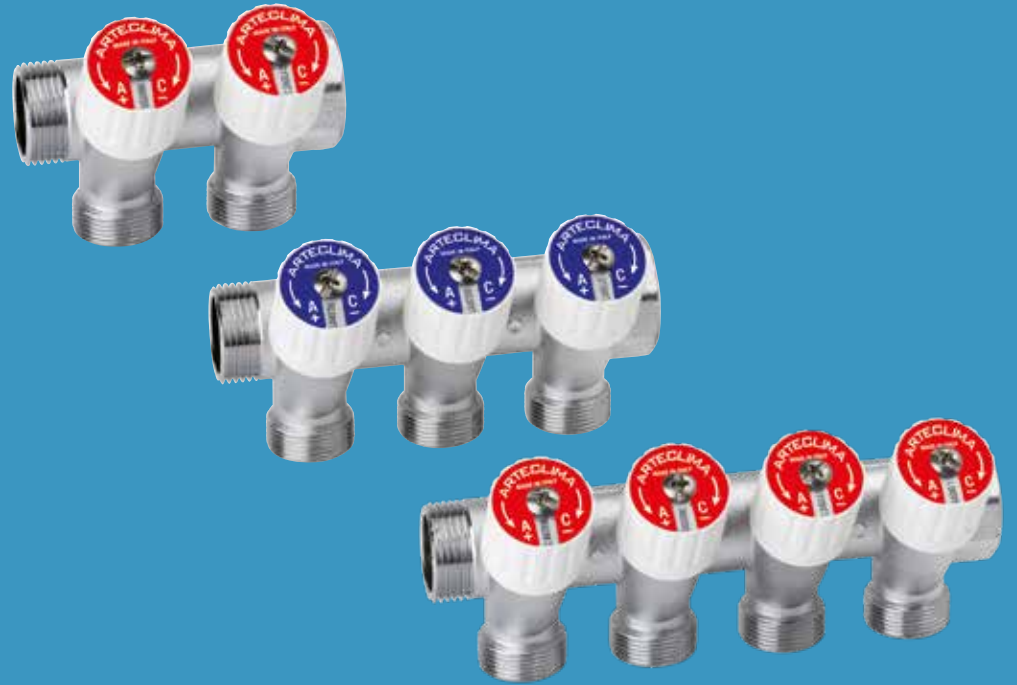



## Collettori

Collettori modulari con arresti manuali	116
Collettori modulari con arresti manuali 1/2"	121
Collettori con derivazioni maschio 24x19	122
Collettori complanari	123
Raccordi per tubo rame, plastica e multistrato	124
Accessori per collettori	126
Cassette di ispezione in plastica	128
Collettori di distribuzione premontati	130
Cassette di ispezione in metallo	140
Raccordi per tubo rame, plastica e multistrato	142
Accessori per collettori	144

## Manifolds

<i>Manifolds with manual stoppers</i>	116
<i>Manifolds lateral male connections 1/2"</i>	121
<i>Manifolds lateral male connections 24x19</i>	122
<i>Distribution manifolds</i>	123
<i>Fittings for copper, plastic and multilayer pipe</i>	124
<i>Manifolds accessories</i>	126
<i>Universal plastic cabinets</i>	128
<i>Pre-assembled distribution manifolds</i>	130
<i>Metal cabinets</i>	140
<i>Fittings for copper, plastic and multilayer pipe</i>	142
<i>Manifolds accessories</i>	144



Ogni collettore ha manopole complete di dischetti serigrafati su entrambe le facciate che permettono di selezionare i colori blu o rosso e le descrizioni per impianti sanitari o di riscaldamento.

*Any manifold has handwheels with two disks on every front blue or red printed, with descriptions for sanitary or heating system.*

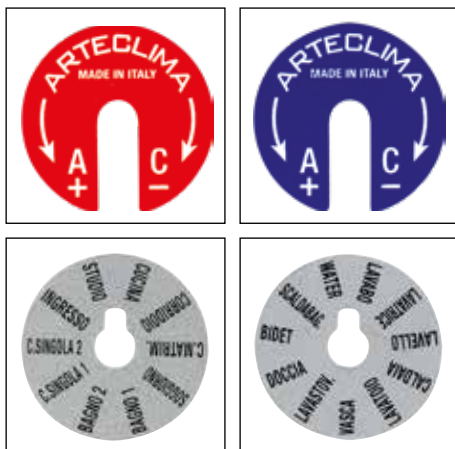

**Collettori con valvole di intercettazione**

- Collettore per impianti sanitari e di riscaldamento
- Corpo in ottone CB753S, norma UNI EN1982
- Vitoni in ottone CW614N, norma UNI EN12164
- Guarnizioni in EPDM al perossido, norma UNI EN681-1
- Manopola ABS bianco RAL9010
- Dischetti in alluminio serigrafato
- Trattamento superficiale cromato
- Pressione massima d'esercizio: 11 bar
- Campo di temperatura: 5÷100°C
- Fluido d'impiego: acqua - soluzioni glicolate (max 30%)
- Attacchi 3/4" M/F oppure attacchi 1" M/F
- Derivazioni filetto 24x19
- Interasse derivazioni 45 mm.

**Manifold with wiretap valve**

- Manifold for sanitary and heating systems
- Brass CB753S body, according to UNI EN1982
- Brass CW614N screw stem, according to UNI EN12164
- Peroxide EPDM monocone, according to UNI EN681-1
- White RAL9010 ABS hand wheel
- Serigraphied aluminium disks
- Chromium plated
- Max operating pressure: 11 Bar
- Temperature range: 5-100°C
- Working fluid: water-glycol fluid (max 30%)
- 3/4" M/F connections or 1" M/F connections
- Thread 24x19
- Center distance connections 45 mm.



Collettore M/F a due derivazioni con detentore per bilanciamento circuiti, filetto 24x19. Attacco tubo rame, plastica e multistrato.  
*Manifold M/F with lockshields and two connections for circuits balance, thread 24x19. For copper, plastic and multilayer pipe.*

6402D			
640342D	3/4"	1	20
64012D	1"	1	20



Collettore M/F a due derivazioni con arresti manuali, filetto 24x19. Attacco tubo rame, plastica e multistrato.  
*Manifold M/F with two manual stoppers, thread 24x19. Connections for copper, plastic and multilayer pipe.*

6402			
640342	3/4"	1	20
64012	1"	1	20



Collettore M/F a tre derivazioni con detentore per bilanciamento circuiti, filetto 24x19. Attacco tubo rame, plastica e multistrato.  
*Manifold M/F with lockshields and three connections for circuits balance, thread 24x19. For copper, plastic and multilayer pipe.*

6403D			
640343D	3/4"	1	20
64013D	1"	1	20



Collettore M/F a tre derivazioni con arresti manuali, filetto 24x19. Attacco tubo rame, plastica e multistrato.  
*Manifold M/F with three manual stoppers, thread 24x19. Connections for copper, plastic and multilayer pipe.*

6403			
640343	3/4"	1	20
64013	1"	1	20



Collettore M/F a quattro derivazioni con detentore per bilanciamento circuiti, filetto 24x19. Attacco tubo rame, plastica e multistrato.  
*Manifold M/F with lockshields and four connections for circuits balance, thread 24x19. For copper, plastic and multilayer pipe.*

6404D			
640344D	3/4"	1	20
64014D	1"	1	20



Collettore M/F a quattro derivazioni con arresti manuali, filetto 24x19. Attacco tubo rame, plastica e multistrato.  
*Manifold M/F with four manual stoppers, thread 24x19. Connections for copper, plastic and multilayer pipe.*

6404			
640344	3/4"	1	20
64014	1"	1	20



Collettore M/F a due derivazioni con detentore per bilanciamento circuiti, filetto 24x19. Attacco tubo rame, plastica e multistrato.  
 Manifold M/F with lockshields and two connections for circuits balance, thread 24x19. For copper, plastic and multilayer pipe.

<b>6402DG</b>			
640342DG	3/4"	1	20
64012DG	1"	1	20



Collettore M/F a due derivazioni con arresti manuali, filetto 24x19. Attacco tubo rame, plastica e multistrato.  
 Manifold M/F with two manual stoppers, thread 24x19. Connections for copper, plastic and multilayer pipe.

<b>6402G</b>			
640342G	3/4"	1	20
64012G	1"	1	20



Collettore M/F a tre derivazioni con detentore per bilanciamento circuiti, filetto 24x19. Attacco tubo rame, plastica e multistrato.  
 Manifold M/F with lockshields and three connections for circuits balance, thread 24x19. For copper, plastic and multilayer pipe.

<b>6403DG</b>			
640343DG	3/4"	1	20
64013DG	1"	1	20



Collettore M/F a tre derivazioni con arresti manuali, filetto 24x19. Attacco tubo rame, plastica e multistrato.  
 Manifold M/F with three manual stoppers, thread 24x19. Connections for copper, plastic and multilayer pipe.

<b>6403G</b>			
640343G	3/4"	1	20
64013G	1"	1	20



Collettore M/F a quattro derivazioni con detentore per bilanciamento circuiti, filetto 24x19. Attacco tubo rame, plastica e multistrato.  
 Manifold M/F with lockshields and four connections for circuits balance, thread 24x19. For copper, plastic and multilayer pipe.

<b>6404DG</b>			
640344DG	3/4"	1	20
64014DG	1"	1	20



Collettore M/F a quattro derivazioni con arresti manuali, filetto 24x19. Attacco tubo rame, plastica e multistrato.  
 Manifold M/F with four manual stoppers, thread 24x19. Connections for copper, plastic and multilayer pipe.

<b>6404G</b>			
640344G	3/4"	1	20
64014G	1"	1	20



Collettore M/F 3/4" a due derivazioni con arresti, filetto 24x19.  
Attacco tubo rame, plastica e multistrato.

*Manifold M/F 3/4" with two stoppers, connections for copper, plastic and multilayer pipe, thread 24x19.*

<b>6392G</b>			
639342G	3/4"	5	25



Collettore M/F 3/4" a tre derivazioni con arresti, filetto 24x19.  
Attacco tubo rame, plastica e multistrato.

*Manifold M/F 3/4" with three stoppers, connections for copper, plastic and multilayer pipe, thread 24x19.*

<b>6393G</b>			
639343G	3/4"	5	25



Collettore M/F 3/4" a quattro derivazioni con arresti, filetto 24x19.  
Attacco tubo rame, plastica e multistrato.

*Manifold M/F 3/4" with four stoppers, connections for copper, plastic and multilayer pipe, thread 24x19.*

<b>6394G</b>			
639344G	3/4"	5	25



Ogni collettore ha manopole complete di dischetti serigrafati su entrambe le facciate che permettono di selezionare i colori blu o rosso e le descrizioni per impianti sanitari o di riscaldamento.

*Any manifold has handwheels with two disks on every front blue or red printed, with descriptions for sanitary or heating system.*



Collettore M/F 3/4" a due derivazioni con arresti, filetto 24x19.  
 Attacco tubo rame, plastica e multistrato.

*Manifold M/F 3/4" with two stoppers, connections for copper, plastic and multilayer pipe, thread 24x19.*

<b>6392</b>			
639342	3/4"	5	25



Collettore M/F 3/4" a tre derivazioni con arresti, filetto 24x19.  
 Attacco tubo rame, plastica e multistrato.

*Manifold M/F 3/4" with three stoppers, connections for copper, plastic and multilayer pipe, thread 24x19.*

<b>6393</b>			
639343	3/4"	5	25



Collettore M/F 3/4" a quattro derivazioni con arresti, filetto 24x19.  
 Attacco tubo rame, plastica e multistrato.

*Manifold M/F 3/4" with four stoppers, connections for copper, plastic and multilayer pipe, thread 24x19.*

<b>6394</b>			
639344	3/4"	5	25



Chiave poligonale per calotte esagono 24 e 27 mm.

*Polygon spanner for 24 and 27 mm hexagon nuts.*

<b>637</b>		
637	24-27	1



Ogni collettore ha manopole complete di dischetti serigrafati su entrambe le facciate che permettono di selezionare i colori blu o rosso e le descrizioni per impianti sanitari o di riscaldamento.



*Any manifold has handwheels with two disks on every front blue or red printed, with descriptions for sanitary or heating system.*

ATTACCO  
 1/2"  
 CONNECTION



Collettore M/F a due derivazioni attacco 1/2" femmina.  
 Interasse derivazioni 45 mm.

Manifold M/F with two connections 1/2" female.  
 Center distance 45 mm.



<b>6402F</b>			
640342F	3/4"	1	20
64012F	1"	1	20

ATTACCO  
 1/2"  
 CONNECTION



Collettore M/F a tre derivazioni attacco 1/2" femmina.  
 Interasse derivazioni 45 mm.

Manifold M/F with three connections 1/2" female.  
 Center distance 45 mm.



<b>6403F</b>			
640343F	3/4"	1	20
64013F	1"	1	20

ATTACCO  
 1/2"  
 CONNECTION



Collettore M/F a quattro derivazioni attacco 1/2" femmina.  
 Interasse derivazioni 45 mm.

Manifold M/F with four connections 1/2" female.  
 Center distance 45 mm.

<b>6404F</b>			
640344F	3/4"	1	20
64014F	1"	1	20



Collettore M/F cromato a due derivazioni laterali, filetto 24x19.  
 Attacco tubo rame, plastica e multistrato.

*Chromium-plated manifold M/F with two lateral connections  
 for copper, plastic and multilayer pipe, thread 24x19.*

<b>600C</b>			
60034C	3/4"	10	50
6001C	1"	10	50



Collettore M/F a due derivazioni laterali, filetto 24x19.  
 Attacco tubo rame, plastica e multistrato.

*Manifold M/F with two lateral connections  
 for copper, plastic and multilayer pipe, thread 24x19.*

<b>600</b>			
60034	3/4"	10	50
6001	1"	10	50



Collettore M/F cromato a tre derivazioni laterali, filetto 24x19.  
 Attacco tubo rame, plastica e multistrato.

*Chromium-plated manifold M/F with three lateral connections  
 for copper, plastic and multilayer pipe, thread 24x19.*

<b>601C</b>			
60134C	3/4"	10	50
6011C	1"	10	50



Collettore M/F a tre derivazioni laterali, filetto 24x19.  
 Attacco tubo rame, plastica e multistrato.

*Manifold M/F with three lateral connections  
 for copper, plastic and multilayer pipe, thread 24x19.*

<b>601</b>			
60134	3/4"	10	50
6011	1"	10	50



Collettore M/F cromato a quattro derivazioni laterali, filetto 24x19.  
 Attacco tubo rame, plastica e multistrato.

*Chromium-plated manifold M/F with four lateral connections  
 for copper, plastic and multilayer pipe, thread 24x19.*

<b>602C</b>			
60234C	3/4"	10	50
6021C	1"	8	40



Collettore M/F a quattro derivazioni laterali, filetto 24x19.  
 Attacco tubo rame, plastica e multistrato.

*Manifold M/F with four lateral connections  
 for copper, plastic and multilayer pipe, thread 24x19.*

<b>602</b>			
60234	3/4"	10	50
6021	1"	8	40





Collettore componibile in ottone cromato con derivazioni, filetto 24x19. Attacco tubo rame, plastica e multistrato, corredato di vite 8MA e O-Ring per accoppiamento.

*Chromium-plated brass distribution manifold, thread 24x19, with connections for copper, plastic and multilayer pipe and with 8MA screw and O-rings for connection.*

630				
63034	3/4"	2+2	1	20
6301	1"	2+2	1	20



Collettore componibile in ottone giallo con derivazioni, filetto 24x19. Attacco tubo rame, plastica e multistrato, corredato di vite 8MA e O-Ring per accoppiamento.

*Yellow brass distribution manifold, thread 24x19, with connections for copper, plastic and multilayer pipe and with 8MA screw and O-rings for connection.*

631				
63134	3/4"	2+2	1	20
6311	1"	2+2	1	20



Collettore componibile premontato con derivazioni, filetto 24x19. Attacco tubo rame, plastica e multistrato.

*Pre-assembled distribution manifold with connections for copper, plastic and multilayer pipe, thread 24x19.*

635			
635344	3/4"	4+4	1
635346	3/4"	6+6	1
635348	3/4"	8+8	1
6353410	3/4"	10+10	1
63514	1"	4+4	1
63516	1"	6+6	1
63518	1"	8+8	1
635110	1"	10+10	1



Collettore componibile premontato con derivazioni, filetto 24x19. Attacco tubo rame, plastica e multistrato.

*Pre-assembled distribution manifold with connections for copper, plastic and multilayer pipe, thread 24x19.*

636			
636344	3/4"	4+4	1
636346	3/4"	6+6	1
636348	3/4"	8+8	1
6363410	3/4"	10+10	1
63614	1"	4+4	1
63616	1"	6+6	1
63618	1"	8+8	1
636110	1"	10+10	1



Vite a brugola di ricambio per collettore serie 630 - 631.  
*Screw parts for distribution manifold series 630 - 631.*

633		
6338	8MA	10
63310	10MA	10



Anello O-ring in EPDM per accoppiamento collettore serie 630/631.

*O-ring EPDM for distribution manifold series 630/631.*

634		
63434	3/4"	10
6341	1"	10

**Sistema intercambiabile** per tubo rame, plastica e multistrato. **Interchangeable system** for copper, plastic and multilayer pipe.

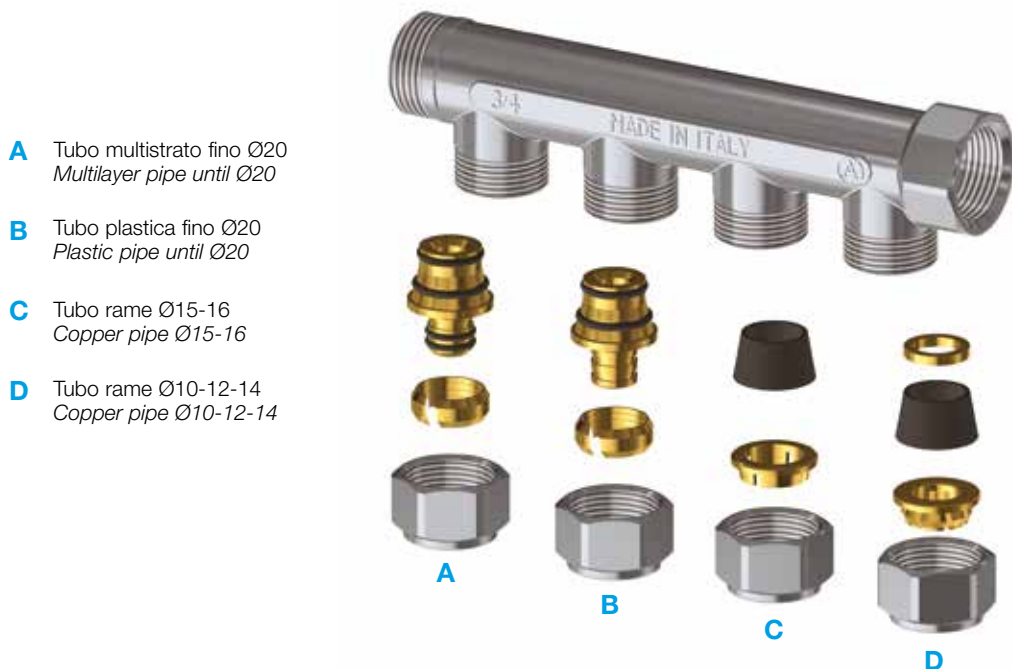

#### CARATTERISTICHE TECNICHE

- Calotta ES.27 ottone CW 617N, Norma UNI EN 12165
  - Guarnizioni EPDM perossido, norma UNI EN 681-1,  
**(non adatte in presenza di oli minerali e idrocarburi)**
- Adattatori anelli, serraturubi ottone CW614N, norma UNI EN12164
- Fluido d'impiego: acqua (anche potabile), soluzioni glicolate Max 30%
- Pressione massima d'esercizio: 12 bar
- Campo di temperatura: -20°C ÷ +110°C.

#### TECHNICAL DATA

- Nut of CW 617N brass, according to UNI EN 12165
  - EPDM peroxide O-ring, according to UNI EN 681-1,  
**(not in presence of mineral oil and hydrocarbon)**
- Adapter, ring, pipe lock of CW614N brass, according to UNI EN12164
- Working fluid: water (also potable), glycol fluid Max 30%
- Max operating pressure: 12 bar
- Temperature range: from -20°C to +110°C.



Raccordo a compressione per tubo rame monocono in gomma.  
 Calotta filetto 24x19 gialla.

*Compression fitting connection for copper pipe.  
 Rubber monocone and yellow brass nut thread 24x19.*

<b>720</b>			
72010	Ø10	50	250
72012	Ø12	50	250
72014	Ø14	50	250



Raccordo a compressione per tubo rame monocono in gomma.  
 Calotta filetto 24x19 cromata.

*Compression fitting connection for copper pipe.  
 Rubber monocone and chromium-plated brass nut thread 24x19.*

<b>720C</b>			
72010C	Ø10	50	250
72012C	Ø12	50	250
72014C	Ø14	50	250



Raccordo a compressione per tubo rame monocono in gomma.  
 Calotta filetto 24x19 gialla.

*Compression fitting connection for copper pipe.  
 Rubber monocone and yellow brass nut thread 24x19.*

<b>721</b>			
72115	Ø15	50	250
72116	Ø16	50	250



Raccordo a compressione per tubo rame monocono in gomma.  
 Calotta filetto 24x19 cromata.

*Compression fitting connection for copper pipe.  
 Rubber monocone and chromium-plated brass nut thread 24x19.*

<b>721C</b>			
72115C	Ø15	50	250
72116C	Ø16	50	250



Raccordo per tubo plastica. Calotta filetto 24x19 gialla.  
*Fitting for plastic pipe. Yellow brass nut thread 24x19.*

<b>751</b>			
75112	12 x 2	50	250
75115	15 x 2,5	50	250
75116	16 x 2	50	250
75117	17 x 2	50	250
75118	18 x 2,5	50	250
75120	20 x 2	50	250
75125	20 x 2,5	50	250



Raccordo per tubo plastica, calotta filetto 24x19 cromata.  
*Fitting for plastic pipe. Chromium-plated brass nut thread 24x19.*

<b>751C</b>			
75112C	12 x 2	50	250
75115C	15 x 2,5	50	250
75116C	16 x 2	50	250
75117C	17 x 2	50	250
75118C	18 x 2,5	50	250
75120C	20 x 2	50	250
75125C	20 x 2,5	50	250



Raccordo per tubo multistrato. Calotta filetto 24x19 gialla.  
*Fitting for multilayer pipe.  
 Yellow brass nut thread 24x19.*

<b>753</b>			
75314	14 x 2	50	250
75315	15 x 2,5	50	250
75316	16 x 2	50	250
753162	16 x 2,25	50	250
753166	16,2 x 2,6	50	250
753168	16,8 x 2,5	50	250
75317	17 x 2	50	250
753177	17 x 2,7	50	250
75318	18 x 2	50	250
75320	20 x 2	50	250
753202	20 x 2,25	50	250
75325	20 x 2,5	50	250
75329	20 x 2,9	50	250



Raccordo per tubo multistrato, calotta filetto 24x19 cromata.  
*Fitting for multilayer pipe.  
 Chromium-plated brass nut thread 24x19.*

<b>753C</b>			
75314C	14 x 2	50	250
75315C	15 x 2,5	50	250
75316C	16 x 2	50	250
753162C	16 x 2,25	50	250
753166C	16,2 x 2,6	50	250
753168C	16,8 x 2,5	50	250
75317C	17 x 2	50	250
753177C	17 x 2,7	50	250
75318C	18 x 2	50	250
75320C	20 x 2	50	250
753202C	20 x 2,25	50	250
75325C	20 x 2,5	50	250
75329C	20 x 2,9	50	250

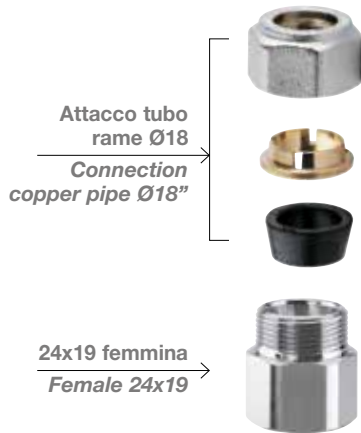

Prolunga cromata filetto 24x19 femmina ad attacco tubo rame Ø18.  
Female fitting thread 24x19, connection for copper pipe Ø18.  
Chromium-plated.

<b>853</b>			
85318G	24x19F - Ø18	30 mm	25

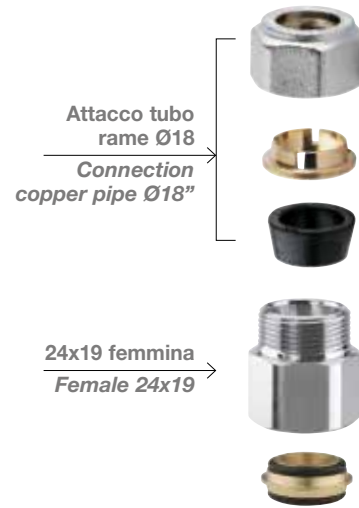

Prolunga cromata filetto 24x19 femmina ad attacco tubo rame Ø18 con ogiva di tenuta.  
Female fitting thread 24x19, connection for copper pipe Ø18 with seal. Chromium-plated.

<b>863</b>			
86318G	24x19F - Ø18	30 mm	25

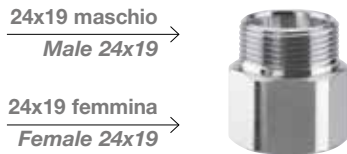

Prolunga cromata filetto 24x19 M/F.  
Attacco tubo rame, plastica e multistrato.  
Chromium fitting thread 24x19 M/F.  
Connection for copper, plastic and multilayer pipe.

<b>855</b>			
85524	24x19 M/F	30 mm	25

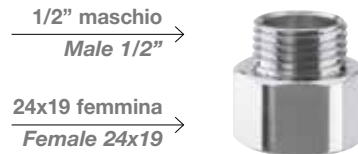

Adattatore cromato da filetto 24x19 ad attacco 1/2" gas maschio.  
Chromium fitting reduction 24x19 for male 1/2" gas connection.

<b>857</b>			
85724	24x19F-1/2"M	30 mm	25



Prolunga cromata filetto 24x19 M/F con ogiva di tenuta.  
Attacco tubo rame, plastica e multistrato.  
Chromium fitting thread 24x19 M/F with seal.  
Connection for copper, plastic and multilayer pipe.

<b>865</b>			
86524	24x19 M/F	30 mm	25

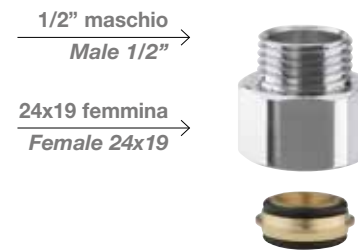

Adattatore cromato da filetto 24x19 ad attacco 1/2" gas maschio con ogiva di tenuta.  
Chromium fitting reduction 24x19 for male 1/2" gas connection with seal.

<b>867</b>			
86724	24x19F-1/2"M	30 mm	25



Tappo di testa femmina con attacco per sfiato.  
Female head cap with discharging connection.

<b>719</b>	<b>F</b>	<b>⊗</b>
7193438	3/4" x 3/8"	25
7193412	3/4" x 1/2"	25
719138	1" x 3/8"	25
719112	1" x 1/2"	25



Tappo di testa femmina con attacco per sfiato.  
Female head cap with discharging connection.

<b>719C</b>	<b>F</b>	<b>⊗</b>
7193438C	3/4" x 3/8"	25
7193412C	3/4" x 1/2"	25
719138C	1" x 3/8"	25
719112C	1" x 1/2"	25

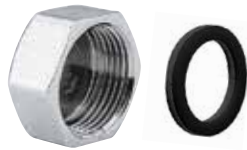

Tappo cieco cromato con guarnizione.  
Chromium-plated end cap with seal.

<b>620C</b>	<b>F</b>	<b>⊗</b>
62012C	1/2"	50
62034C	3/4"	50
6201C	1"	50
620114C	1"1/4	50



Tappo maschio cromato con tenuta O-ring.  
Chromium-plated male end cap with O-ring seal.

<b>621C</b>	<b>F</b>	<b>⊗</b>
62112C	1/2"	50
62134C	3/4"	50
6211C	1"	50
621114C	1"1/4	50



Tappo cieco giallo filetto 24x19 con guarnizione di chiusura.  
Yellow end cap thread 24x19 with closing seal.

<b>623</b>	<b>F</b>	<b>⊗</b>
623	24x19	50

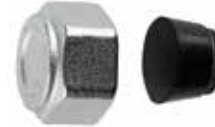

Tappo cieco cromato filetto 24x19 con guarnizione di chiusura.  
Chromium-plated end cap thread 24x19 with closing seal.

<b>623C</b>	<b>F</b>	<b>⊗</b>
623C	24x19	50



Tappo di testa maschio cromato con foro di riduzione.  
Chromium-plated male head cap with reduction.

<b>624C</b>	<b>F</b>	<b>⊗</b>
6243438C	3/4" x 3/8"	50
6243412C	3/4" x 1/2"	50
624138C	1" x 3/8"	50
624112C	1" x 1/2"	50
62411412C	1"1/4 x 1/2"	50
62411434C	1"1/4 x 3/4"	50
6241141C	1"1/4 x 1"	50



Tappo di testa femmina cromato con foro di riduzione.  
Chromium-plated female head cap with reduction.

<b>625C</b>	<b>F</b>	<b>⊗</b>
6253438C	3/4" x 3/8"	50
625138C	1" x 3/8"	50
625112C	1" x 1/2"	50





Scelta indicativa della cassetta in plastica art. **665/666**  
 in funzione del numero di vie installabili per i vari collettori.  
 Nella determinazione degli ingombri è stata considerata la  
 presenza di un tappo di testa e un raccordo curvo.

*Indication for the choise of the plastic cabinets items*



**665/666**

*based on the number of the manifolds connections and the  
 dimensions of: one head cap and elbow fitting.*



**Collettore lineare serie 600**  
**Linear manifold 600 items**

	
3	320
4	320
5	320
6	400
7	400
8	500
9	500
10	500
11	600
12	600



**Collettore complanare serie 630 - 631**  
**Distribution manifold 630 - 631 items**

	
4+4	320
6+6	400
8+8	500
10+10	600
12+12	600

**Collettore con arresti serie 640**  
**Manifold with stop 640 items**

	
3	320
4	320
5	400
6	400
7	500
8	500
9	600
10	600

**Collettore con arresti serie 639**  
**Manifold with stop 639 items**

	
3	320
4	320
5	320
6	400
7	400
8	500
9	500
10	500
11	600
12	600



Cassetta in plastica componibile completa di supporti per il fissaggio di collettori: semplici, con arresti, complanari da 3/4" e 1".

*Modular universal plastic cabinet with brackets and stop for drawn manifolds.*

<b>665</b>	<b>f</b>	<b>⊗</b>
66532	320 x 260 x 95	20
66540	400 x 260 x 95	20
66550	500 x 260 x 95	10
66560	600 x 260 x 95	10

Cassetta in plastica monoblocco completa di supporti per il fissaggio di collettori: semplici, con arresti, complanari da 3/4" e 1".

*Monoblock universal plastic cabinet with brackets and stop for drawn manifolds.*

<b>666</b>	<b>f</b>	<b>⊗</b>
66632	320 x 260 x 95	8
66640	400 x 260 x 95	8
66650	500 x 260 x 95	8
66660	600 x 260 x 95	8

### Ricambi Spare parts

Coperchio di ricambio per cassetta **665 - 666**.

*Spare cover for cabinet 665 - 666.*

	<b>f</b>	<b>⊗</b>
665132	320 x 260	1
665140	400 x 260	1
665150	500 x 260	1
665160	600 x 260	1

Kit 2 viti in plastica di ricambio per coperchio cassetta **665 - 666**.

*Kit 2 plastic screws for cover cabinet 665 - 666.*

	<b>⊗</b>	<b>⊗</b>
66510	2	50



Kit supporti di ricambio cassetta **665 - 666**.

*Kit of spare parts for cabinet 665 - 666.*

	<b>f</b>	<b>⊗</b>
66520	KIT	10



Telaio e coperchio in plastica.

*Plastic frame and cover.*

<b>650</b>	<b>f</b>	<b>⊗</b>
65032	320 x 260	10
65040	400 x 260	10
65050	500 x 260	10
65060	600 x 260	10



Collettore di distribuzione F/F 1" premontato con raccordi.  
Attacco tubo rame, plastica e multistrato, **cromato**.

Pre-assembled distribution manifold F/F 1".  
Connection for copper, plastic and multilayer pipe.  
**Chromium-plated.**

607C	f	⊗
6071C2	1" x 2 vie (24x19)	10
6071C3	1" x 3 vie (24x19)	10
6071C4	1" x 4 vie (24x19)	10
6071C5	1" x 5 vie (24x19)	10
6071C6	1" x 6 vie (24x19)	5
6071C7	1" x 7 vie (24x19)	5
6071C8	1" x 8 vie (24x19)	5
6071C9	1" x 9 vie (24x19)	5
6071C10	1" x 10 vie (24x19)	5
6071C11	1" x 11 vie (24x19)	5
6071C12	1" x 12 vie (24x19)	5

Collettore di distribuzione F/F 1 1/4" premontato con raccordi.  
Attacco tubo rame, plastica e multistrato, **cromato**.

Pre-assembled distribution manifold F/F 1 1/4".  
Connection for copper, plastic and multilayer pipe.  
**Chromium-plated.**

607C	f	⊗
60714C2	1"1/4 x 2 vie (24x19)	10
60714C3	1"1/4 x 3 vie (24x19)	10
60714C4	1"1/4 x 4 vie (24x19)	10
60714C5	1"1/4 x 5 vie (24x19)	10
60714C6	1"1/4 x 6 vie (24x19)	5
60714C7	1"1/4 x 7 vie (24x19)	5
60714C8	1"1/4 x 8 vie (24x19)	5
60714C9	1"1/4 x 9 vie (24x19)	5
60714C10	1"1/4 x 10 vie (24x19)	5
60714C11	1"1/4 x 11 vie (24x19)	5
60714C12	1"1/4 x 12 vie (24x19)	5

607E	f	⊗
6071E2	1" x 2 vie (3/4" Eurocono)	10
6071E3	1" x 3 vie (3/4" Eurocono)	10
6071E4	1" x 4 vie (3/4" Eurocono)	10
6071E5	1" x 5 vie (3/4" Eurocono)	10
6071E6	1" x 6 vie (3/4" Eurocono)	5
6071E7	1" x 7 vie (3/4" Eurocono)	5
6071E8	1" x 8 vie (3/4" Eurocono)	5
6071E9	1" x 9 vie (3/4" Eurocono)	5
6071E10	1" x 10 vie (3/4" Eurocono)	5
6071E11	1" x 11 vie (3/4" Eurocono)	5
6071E12	1" x 12 vie (3/4" Eurocono)	5

607E	f	⊗
60714E2	1"1/4 x 2 vie (3/4" Eurocono)	10
60714E3	1"1/4 x 3 vie (3/4" Eurocono)	10
60714E4	1"1/4 x 4 vie (3/4" Eurocono)	10
60714E5	1"1/4 x 5 vie (3/4" Eurocono)	10
60714E6	1"1/4 x 6 vie (3/4" Eurocono)	5
60714E7	1"1/4 x 7 vie (3/4" Eurocono)	5
60714E8	1"1/4 x 8 vie (3/4" Eurocono)	5
60714E9	1"1/4 x 9 vie (3/4" Eurocono)	5
60714E10	1"1/4 x 10 vie (3/4" Eurocono)	5
60714E11	1"1/4 x 11 vie (3/4" Eurocono)	5
60714E12	1"1/4 x 12 vie (3/4" Eurocono)	5

607P	f	⊗
6071P2	1" x 2 vie (3/4" testa piana)	10
6071P3	1" x 3 vie (3/4" testa piana)	10
6071P4	1" x 4 vie (3/4" testa piana)	10
6071P5	1" x 5 vie (3/4" testa piana)	10
6071P6	1" x 6 vie (3/4" testa piana)	5
6071P7	1" x 7 vie (3/4" testa piana)	5
6071P8	1" x 8 vie (3/4" testa piana)	5
6071P9	1" x 9 vie (3/4" testa piana)	5
6071P10	1" x 10 vie (3/4" testa piana)	5
6071P11	1" x 11 vie (3/4" testa piana)	5
6071P12	1" x 12 vie (3/4" testa piana)	5

607P	f	⊗
60714P2	1"1/4 x 2 vie (3/4" testa piana)	10
60714P3	1"1/4 x 3 vie (3/4" testa piana)	10
60714P4	1"1/4 x 4 vie (3/4" testa piana)	10
60714P5	1"1/4 x 5 vie (3/4" testa piana)	10
60714P6	1"1/4 x 6 vie (3/4" testa piana)	5
60714P7	1"1/4 x 7 vie (3/4" testa piana)	5
60714P8	1"1/4 x 8 vie (3/4" testa piana)	5
60714P9	1"1/4 x 9 vie (3/4" testa piana)	5
60714P10	1"1/4 x 10 vie (3/4" testa piana)	5
60714P11	1"1/4 x 11 vie (3/4" testa piana)	5
60714P12	1"1/4 x 12 vie (3/4" testa piana)	5





Raccordo diritto M/M con O-ring per collettori serie 607.

*Straight fitting M/M with O-ring for 607 series.*

<b>626</b>	<b>f</b>	<b>⊗</b>
6261	1"	1
626114	1"1/4	1



Coppia staffe metalliche per fissaggio collettori di distribuzione.

*Couple of metal brackets for drawn distribution manifolds.*

<b>607S</b>	<b>f</b>	<b>⊗</b>
6071S	1"	2
607114S	1"1/4	2



Collettore da barra F/F derivazioni 1/2" gas femmina.

**Finitura cromata.**

*Drawn manifold female connections 1/2" gas.*

**Chromium-plated.**

<b>606C</b>	<b>f</b>	<b>⊗</b>
60612C	1" x 2 vie (1/2")	1
60613C	1" x 3 vie (1/2")	1
60614C	1" x 4 vie (1/2")	1
60615C	1" x 5 vie (1/2")	1
60616C	1" x 6 vie (1/2")	1
60617C	1" x 7 vie (1/2")	1
60618C	1" x 8 vie (1/2")	1
60619C	1" x 9 vie (1/2")	1
606110C	1" x 10 vie (1/2")	1
606111C	1" x 11 vie (1/2")	1
606112C	1" x 12 vie (1/2")	1
606142C	1"1/4 x 2 vie (1/2")	1
606143C	1"1/4 x 3 vie (1/2")	1
606144C	1"1/4 x 4 vie (1/2")	1
606145C	1"1/4 x 5 vie (1/2")	1
606146C	1"1/4 x 6 vie (1/2")	1
606147C	1"1/4 x 7 vie (1/2")	1
606148C	1"1/4 x 8 vie (1/2")	1
606149C	1"1/4 x 9 vie (1/2")	1
6061410C	1"1/4 x 10 vie (1/2")	1
6061411C	1"1/4 x 11 vie (1/2")	1
6061412C	1"1/4 x 12 vie (1/2")	1



Collettore di distribuzione con valvoni termostattizzabili incorporati predisposti per collegamento elettrotermico (art. 315 - 319) e volantino per regolazione manuale, connessioni attacco tubo rame, plastica e multistrato, **cromato**.

**Chromium-plated** pre-assembled distribution manifold with valves prepared for the thermoelectric regulation (art. 315 - 319) handwheel manual control.  
Connection for copper, plastic and multilayer pipe.



Collettore di distribuzione con valvoni termostattizzabili incorporati predisposti per collegamento elettrotermico (art. 315 - 319) e cappuccio di protezione, connessioni attacco tubo rame, plastica e multistrato, **cromato**.

**Chromium-plated** pre-assembled distribution manifold with valves prepared for the thermoelectric regulation (art. 315 - 319) and protection cap.  
Connection for copper, plastic and multilayer pipe.

607VTC		
607VTC2	1" x 2 vie (24x19)	1
607VTC3	1" x 3 vie (24x19)	1
607VTC4	1" x 4 vie (24x19)	1
607VTC5	1" x 5 vie (24x19)	1
607VTC6	1" x 6 vie (24x19)	1
607VTC7	1" x 7 vie (24x19)	1
607VTC8	1" x 8 vie (24x19)	1
607VTC9	1" x 9 vie (24x19)	1
607VTC10	1" x 10 vie (24x19)	1
607VTC11	1" x 11 vie (24x19)	1
607VTC12	1" x 12 vie (24x19)	1

607VC		
607VC2	1" x 2 vie (24x19)	1
607VC3	1" x 3 vie (24x19)	1
607VC4	1" x 4 vie (24x19)	1
607VC5	1" x 5 vie (24x19)	1
607VC6	1" x 6 vie (24x19)	1
607VC7	1" x 7 vie (24x19)	1
607VC8	1" x 8 vie (24x19)	1
607VC9	1" x 9 vie (24x19)	1
607VC10	1" x 10 vie (24x19)	1
607VC11	1" x 11 vie (24x19)	1
607VC12	1" x 12 vie (24x19)	1

607VTE		
607VTE2	1" x 2 vie (3/4" Eurocono)	1
607VTE3	1" x 3 vie (3/4" Eurocono)	1
607VTE4	1" x 4 vie (3/4" Eurocono)	1
607VTE5	1" x 5 vie (3/4" Eurocono)	1
607VTE6	1" x 6 vie (3/4" Eurocono)	1
607VTE7	1" x 7 vie (3/4" Eurocono)	1
607VTE8	1" x 8 vie (3/4" Eurocono)	1
607VTE9	1" x 9 vie (3/4" Eurocono)	1
607VTE10	1" x 10 vie (3/4" Eurocono)	1
607VTE11	1" x 11 vie (3/4" Eurocono)	1
607VTE12	1" x 12 vie (3/4" Eurocono)	1

607VE		
607VE2	1" x 2 vie (3/4" Eurocono)	1
607VE3	1" x 3 vie (3/4" Eurocono)	1
607VE4	1" x 4 vie (3/4" Eurocono)	1
607VE5	1" x 5 vie (3/4" Eurocono)	1
607VE6	1" x 6 vie (3/4" Eurocono)	1
607VE7	1" x 7 vie (3/4" Eurocono)	1
607VE8	1" x 8 vie (3/4" Eurocono)	1
607VE9	1" x 9 vie (3/4" Eurocono)	1
607VE10	1" x 10 vie (3/4" Eurocono)	1
607VE11	1" x 11 vie (3/4" Eurocono)	1
607VE12	1" x 12 vie (3/4" Eurocono)	1

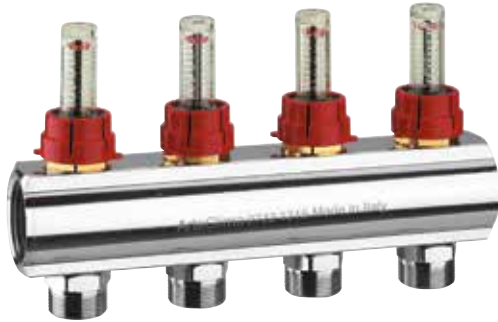

Collettore di distribuzione premontato con regolatori e misuratori di portata, connessioni attacco tubo rame, plastica e multistrato, **cromato**.

**Chromium-plated** pre-assembled distribution manifold with regulators and flow meters.  
Connection for copper, plastic and multilayer pipe.



Collettore di distribuzione premontato con detettori incorporati, connessioni attacco tubo rame, plastica e multistrato, **cromato**.

**Chromium-plated** pre-assembled distribution manifold with lockshield. Connection for copper, plastic and multilayer pipe.

607DRC	F	⊗
607DRC2	1" x 2 vie (24x19)	1
607DRC3	1" x 3 vie (24x19)	1
607DRC4	1" x 4 vie (24x19)	1
607DRC5	1" x 5 vie (24x19)	1
607DRC6	1" x 6 vie (24x19)	1
607DRC7	1" x 7 vie (24x19)	1
607DRC8	1" x 8 vie (24x19)	1
607DRC9	1" x 9 vie (24x19)	1
607DRC10	1" x 10 vie (24x19)	1
607DRC11	1" x 11 vie (24x19)	1
607DRC12	1" x 12 vie (24x19)	1

607DC	F	⊗
607DC2	1" x 2 vie (24x19)	1
607DC3	1" x 3 vie (24x19)	1
607DC4	1" x 4 vie (24x19)	1
607DC5	1" x 5 vie (24x19)	1
607DC6	1" x 6 vie (24x19)	1
607DC7	1" x 7 vie (24x19)	1
607DC8	1" x 8 vie (24x19)	1
607DC9	1" x 9 vie (24x19)	1
607DC10	1" x 10 vie (24x19)	1
607DC11	1" x 11 vie (24x19)	1
607DC12	1" x 12 vie (24x19)	1

607DRE	F	⊗
607DRE2	1" x 2 vie (3/4" Eurocono)	1
607DRE3	1" x 3 vie (3/4" Eurocono)	1
607DRE4	1" x 4 vie (3/4" Eurocono)	1
607DRE5	1" x 5 vie (3/4" Eurocono)	1
607DRE6	1" x 6 vie (3/4" Eurocono)	1
607DRE7	1" x 7 vie (3/4" Eurocono)	1
607DRE8	1" x 8 vie (3/4" Eurocono)	1
607DRE9	1" x 9 vie (3/4" Eurocono)	1
607DRE10	1" x 10 vie (3/4" Eurocono)	1
607DRE11	1" x 11 vie (3/4" Eurocono)	1
607DRE12	1" x 12 vie (3/4" Eurocono)	1

607DE	F	⊗
607DE2	1" x 2 vie (3/4" Eurocono)	1
607DE3	1" x 3 vie (3/4" Eurocono)	1
607DE4	1" x 4 vie (3/4" Eurocono)	1
607DE5	1" x 5 vie (3/4" Eurocono)	1
607DE6	1" x 6 vie (3/4" Eurocono)	1
607DE7	1" x 7 vie (3/4" Eurocono)	1
607DE8	1" x 8 vie (3/4" Eurocono)	1
607DE9	1" x 9 vie (3/4" Eurocono)	1
607DE10	1" x 10 vie (3/4" Eurocono)	1
607DE11	1" x 11 vie (3/4" Eurocono)	1
607DE12	1" x 12 vie (3/4" Eurocono)	1



Collettore premontato composto da:

- collettore di andata completo di detentori con regolazione
- collettore di ritorno completo di valvole di intercettazione predisposte per comando elettrotermico (art. 315 - 319)
- supporti di fissaggio

Pre-assembled distribution manifold composed by:

- inlet manifold with regulators
- outlet manifold with intercepting valves arranged for electrothermal control (items 315- 319)
- metal brackets



Collettore premontato composto da:

- collettore di andata completo di regolatori e misuratori di portata
- collettore di ritorno completo di valvole di intercettazione predisposte per comando elettrotermico (art. 315 - 319)
- supporti di fissaggio

Pre-assembled distribution manifold composed by:

- inlet manifold with regulators and flow meters
- outlet manifold with intercepting valves arranged for electrothermal control (items 315 - 319)
- metal brackets

## 607TC

	f	⊗
607TC2	1" x 2 (24x19)	1
607TC3	1" x 3 (24x19)	1
607TC4	1" x 4 (24x19)	1
607TC5	1" x 5 (24x19)	1
607TC6	1" x 6 (24x19)	1
607TC7	1" x 7 (24x19)	1
607TC8	1" x 8 (24x19)	1
607TC9	1" x 9 (24x19)	1
607TC10	1" x 10 (24x19)	1
607TC11	1" x 11 (24x19)	1
607TC12	1" x 12 (24x19)	1

## 607TF

	f	⊗
607TF2	1" x 2 (24x19)	1
607TF3	1" x 3 (24x19)	1
607TF4	1" x 4 (24x19)	1
607TF5	1" x 5 (24x19)	1
607TF6	1" x 6 (24x19)	1
607TF7	1" x 7 (24x19)	1
607TF8	1" x 8 (24x19)	1
607TF9	1" x 9 (24x19)	1
607TF10	1" x 10 (24x19)	1
607TF11	1" x 11 (24x19)	1
607TF12	1" x 12 (24x19)	1

## 607TCE

	f	⊗
607TCE2	1" x 2 3/4" Eurocono	1
607TCE3	1" x 3 3/4" Eurocono	1
607TCE4	1" x 4 3/4" Eurocono	1
607TCE5	1" x 5 3/4" Eurocono	1
607TCE6	1" x 6 3/4" Eurocono	1
607TCE7	1" x 7 3/4" Eurocono	1
607TCE8	1" x 8 3/4" Eurocono	1
607TCE9	1" x 9 3/4" Eurocono	1
607TCE10	1" x 10 3/4" Eurocono	1
607TCE11	1" x 11 3/4" Eurocono	1
607TCE12	1" x 12 3/4" Eurocono	1

## 607TFE

	f	⊗
607TFE2	1" x 2 3/4" Eurocono	1
607TFE3	1" x 3 3/4" Eurocono	1
607TFE4	1" x 4 3/4" Eurocono	1
607TFE5	1" x 5 3/4" Eurocono	1
607TFE6	1" x 6 3/4" Eurocono	1
607TFE7	1" x 7 3/4" Eurocono	1
607TFE8	1" x 8 3/4" Eurocono	1
607TFE9	1" x 9 3/4" Eurocono	1
607TFE10	1" x 10 3/4" Eurocono	1
607TFE11	1" x 11 3/4" Eurocono	1
607TFE12	1" x 12 3/4" Eurocono	1





Collettore premontato composto da:

- collettore di andata completo di detentori con regolazione
- collettore di ritorno completo di valvole di intercettazione predisposte per comando elettrotermico (art. 315 - 319)
- terminali di carico/scarico
- supporti di fissaggio



Pre-assembled distribution manifold composed by:

- inlet manifold with regulators
- outlet manifold with intercepting valves arranged for electrothermal control (items 315 - 319)
- charged/discharged group
- metal brackets

### 607TM

		
607TM2	1" x 2 vie (24x19)	1
607TM3	1" x 3 vie (24x19)	1
607TM4	1" x 4 vie (24x19)	1
607TM5	1" x 5 vie (24x19)	1
607TM6	1" x 6 vie (24x19)	1
607TM7	1" x 7 vie (24x19)	1
607TM8	1" x 8 vie (24x19)	1
607TM9	1" x 9 vie (24x19)	1
607TM10	1" x 10 vie (24x19)	1
607TM11	1" x 11 vie (24x19)	1
607TM12	1" x 12 vie (24x19)	1

### 607TME

		
607TME2	1" x 2 vie (3/4" Eurocono)	1
607TME3	1" x 3 vie (3/4" Eurocono)	1
607TME4	1" x 4 vie (3/4" Eurocono)	1
607TME5	1" x 5 vie (3/4" Eurocono)	1
607TME6	1" x 6 vie (3/4" Eurocono)	1
607TME7	1" x 7 vie (3/4" Eurocono)	1
607TME8	1" x 8 vie (3/4" Eurocono)	1
607TME9	1" x 9 vie (3/4" Eurocono)	1
607TME10	1" x 10 vie (3/4" Eurocono)	1
607TME11	1" x 11 vie (3/4" Eurocono)	1
607TME12	1" x 12 vie (3/4" Eurocono)	1





Collettore premontato composto da:

- collettore di andata completo di detentori con regolazione
- collettore di ritorno completo di valvole di intercettazione predisposte per comando elettrotermico (art. 315 - 319)
- terminali di carico/scarico
- supporti di fissaggio



Pre-assembled distribution manifold composed by:

- inlet manifold with regulators
- outlet manifold with intercepting valves arranged for electrothermal control (items 315 - 319)
- charged/discharged group
- metal brackets

### 607TA

		
607TA2	1" x 2 vie (24x19)	1
607TA3	1" x 3 vie (24x19)	1
607TA4	1" x 4 vie (24x19)	1
607TA5	1" x 5 vie (24x19)	1
607TA6	1" x 6 vie (24x19)	1
607TA7	1" x 7 vie (24x19)	1
607TA8	1" x 8 vie (24x19)	1
607TA9	1" x 9 vie (24x19)	1
607TA10	1" x 10 vie (24x19)	1
607TA11	1" x 11 vie (24x19)	1
607TA12	1" x 12 vie (24x19)	1

### 607TAE

		
607TAE2	1" x 2 vie (3/4" Eurocono)	1
607TAE3	1" x 3 vie (3/4" Eurocono)	1
607TAE4	1" x 4 vie (3/4" Eurocono)	1
607TAE5	1" x 5 vie (3/4" Eurocono)	1
607TAE6	1" x 6 vie (3/4" Eurocono)	1
607TAE7	1" x 7 vie (3/4" Eurocono)	1
607TAE8	1" x 8 vie (3/4" Eurocono)	1
607TAE9	1" x 9 vie (3/4" Eurocono)	1
607TAE10	1" x 10 vie (3/4" Eurocono)	1
607TAE11	1" x 11 vie (3/4" Eurocono)	1
607TAE12	1" x 12 vie (3/4" Eurocono)	1



Collettore premontato composto da:

- collettore di andata completo di regolatori e misuratori di portata
- collettore di ritorno completo di valvole di intercettazione predisposte per comando elettrotermico (art. 315 - 319)
- gruppi di carico/scarico con termometro
- supporti di fissaggio

Pre-assembled distribution manifold composed by:

- inlet manifold with regulators and flow meters
- outlet manifold with intercepting valves arranged for electrothermal control (items 315 - 319)
- charged/discharged group with thermometer
- metal brackets

## 607TR

	f	⊗
607TR2	1" x 2 vie (24x19)	1
607TR3	1" x 3 vie (24x19)	1
607TR4	1" x 4 vie (24x19)	1
607TR5	1" x 5 vie (24x19)	1
607TR6	1" x 6 vie (24x19)	1
607TR7	1" x 7 vie (24x19)	1
607TR8	1" x 8 vie (24x19)	1
607TR9	1" x 9 vie (24x19)	1
607TR10	1" x 10 vie (24x19)	1
607TR11	1" x 11 vie (24x19)	1
607TR12	1" x 12 vie (24x19)	1

## 607TRE

	f	⊗
607TRE2	1" x 2 vie (3/4" Eurocono)	1
607TRE3	1" x 3 vie (3/4" Eurocono)	1
607TRE4	1" x 4 vie (3/4" Eurocono)	1
607TRE5	1" x 5 vie (3/4" Eurocono)	1
607TRE6	1" x 6 vie (3/4" Eurocono)	1
607TRE7	1" x 7 vie (3/4" Eurocono)	1
607TRE8	1" x 8 vie (3/4" Eurocono)	1
607TRE9	1" x 9 vie (3/4" Eurocono)	1
607TRE10	1" x 10 vie (3/4" Eurocono)	1
607TRE11	1" x 11 vie (3/4" Eurocono)	1
607TRE12	1" x 12 vie (3/4" Eurocono)	1

Collettore premontato composto da:

- collettore di andata completo di regolatori e misuratori di portata
- collettore di ritorno completo di valvole di intercettazione predisposte per comando elettrotermico (art. 315 - 319)
- gruppi di carico/scarico
- supporti di fissaggio

Pre-assembled distribution manifold composed by:

- inlet manifold with regulators and flow meters
- outlet manifold with intercepting valves arranged for electrothermal control (items 315 - 319)
- charged/discharged group
- metal brackets

## 607TS

	f	⊗
607TS2	1" x 2 vie (24x19)	1
607TS3	1" x 3 vie (24x19)	1
607TS4	1" x 4 vie (24x19)	1
607TS5	1" x 5 vie (24x19)	1
607TS6	1" x 6 vie (24x19)	1
607TS7	1" x 7 vie (24x19)	1
607TS8	1" x 8 vie (24x19)	1
607TS9	1" x 9 vie (24x19)	1
607TS10	1" x 10 vie (24x19)	1
607TS11	1" x 11 vie (24x19)	1
607TS12	1" x 12 vie (24x19)	1

## 607TSE

	f	⊗
607TSE2	1" x 2 vie (3/4" Eurocono)	1
607TSE3	1" x 3 vie (3/4" Eurocono)	1
607TSE4	1" x 4 vie (3/4" Eurocono)	1
607TSE5	1" x 5 vie (3/4" Eurocono)	1
607TSE6	1" x 6 vie (3/4" Eurocono)	1
607TSE7	1" x 7 vie (3/4" Eurocono)	1
607TSE8	1" x 8 vie (3/4" Eurocono)	1
607TSE9	1" x 9 vie (3/4" Eurocono)	1
607TSE10	1" x 10 vie (3/4" Eurocono)	1
607TSE11	1" x 11 vie (3/4" Eurocono)	1
607TSE12	1" x 12 vie (3/4" Eurocono)	1

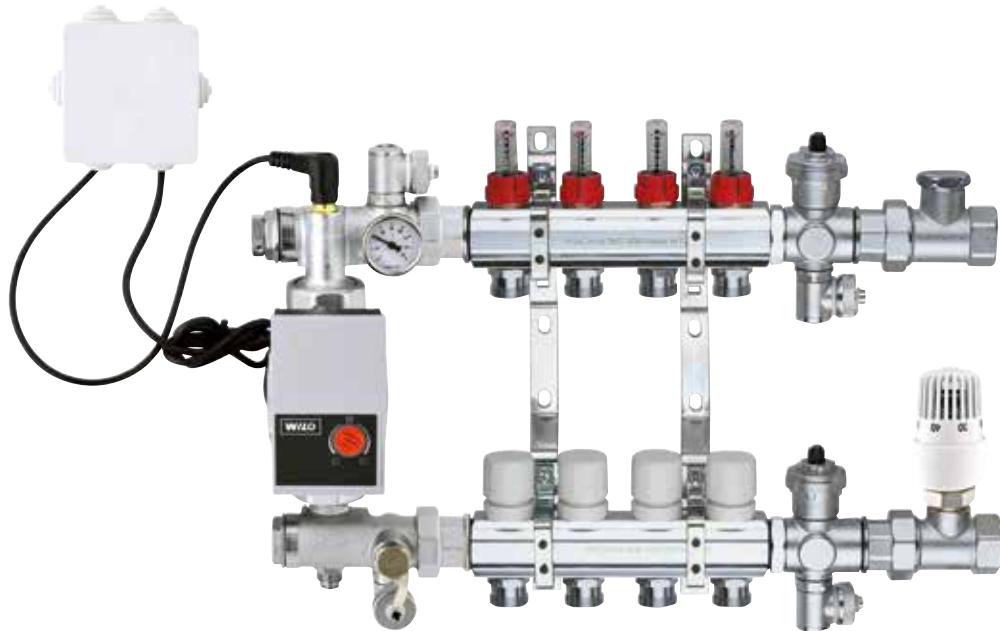

#### Caratteristiche

Gruppo premontato per impianti a pannelli radianti composto da:

- collettore di andata completo di regolatori e misuratori di portata
- collettore di ritorno completo di valvole di intercettazione predisposte per comando elettrotermico (art. 315 - 319)
- set pompa di circolazione ad alta efficienza
- termostato di sicurezza +55° e testa termostatica con sensore -+20°->+65°
- gruppi di carico/scarico
- supporti di fissaggio

#### Characteristics

Assembled distribution manifold for floor heating system composed by:

- inlet manifold with regulators and flow meters
- outlet manifolds with intercepting valves predisposed for electro thermal control (items 315 - 319)
- kit with high efficiency circulation pump
- safety contact thermostat +55° and thermostatic head with sensor -+20°->+65°
- charged/discharged groups
- brackets



Collettore di distribuzione premontato da 1" con uscite, attacco tubo rame, plastica e multistrato, **cromato**.

Pre-assembled distribution manifold 1", **chromium-plated**.  
Connection for copper, plastic and multilayer pipe.

#### 607GDS

	f	⊗
607GDS2	1" x 2 (24x19)	1
607GDS3	1" x 3 (24x19)	1
607GDS4	1" x 4 (24x19)	1
607GDS5	1" x 5 (24x19)	1
607GDS6	1" x 6 (24x19)	1
607GDS7	1" x 7 (24x19)	1
607GDS8	1" x 8 (24x19)	1
607GDS9	1" x 9 (24x19)	1
607GDS10	1" x 10 (24x19)	1
607GDS11	1" x 11 (24x19)	1
607GDS12	1" x 12 (24x19)	1

#### 607GDSE

	f	⊗
607GDSE2	1" x 2 3/4" Eurocono	1
607GDSE3	1" x 3 3/4" Eurocono	1
607GDSE4	1" x 4 3/4" Eurocono	1
607GDSE5	1" x 5 3/4" Eurocono	1
607GDSE6	1" x 6 3/4" Eurocono	1
607GDSE7	1" x 7 3/4" Eurocono	1
607GDSE8	1" x 8 3/4" Eurocono	1
607GDSE9	1" x 9 3/4" Eurocono	1
607GDSE10	1" x 10 3/4" Eurocono	1
607GDSE11	1" x 11 3/4" Eurocono	1
607GDSE12	11" x 12 3/4" Eurocono	1



Comando termostatico con sonda a distanza,  
limitazione temperatura del fluido 20°C ÷ 65°C.

*Thermostatic head with remote sensor, limit temperature of the  
fluid from 20°C to 65°C.*

<b>314</b>			
31412	M30 x 1,5	1	10



Azionatore elettrotermico attacco M30 x 1,5.  
Alimentazione a 230 V. (Normalmente chiuso).

*Electrothermal actuator, connection M30 x 1,5.  
Voltage 230 V. (Normally closed).*

<b>315</b>			
31523S	230 V - 4 fili	1	50
31623	230 V - 2 fili	1	50



Azionatore elettrotermico regolabile 230V a 4 fili, attacco M30 x 1,5.

*Adjustable electrothermal actuator 230V with 4 wires, connection  
M30 x 1,5.*

<b>319</b>			
31924	230 V - 4 fili	1	50





Set circolatore ad alta efficienza con attacchi per collettore.  
High efficiency circulation kit with connections for manifold.

**587**

587	f	⊗
	1"	1



Kit di distribuzione fluido alta temperatura per radiatori completo di by-pass. **Finitura cromata.**

High temperature fluid distribution kit with by-pass.  
**Chromium-plated.**

**607GAT**

607GAT2	f	⊗
607GAT3	1" x 2 (24x19)	1
	1" x 3 (24x19)	1



Valvola a sfera, bocchettoni tenuta O-ring per collettore.  
Ball valve for manifold, O-ring seal fitting.

**584**

584B	f	⊗
584R	1"	5
	1"	5



Valvola a sfera ad angolo con termometro, bocchettoni tenuta O-ring per collettore.  
Angle ball valve with thermometer, O-ring seal fitting for manifold.

**585T**

58534TB	f	⊗
58534TR	3/4"	5
5851TB	3/4"	5
5851TB	1"	5
5851TR	1"	5



Valvola a sfera.  
Ball valve.

**584R**

58434R	f	⊗
5841R	3/4"	5
	1"	5



Valvola a sfera ad angolo con bocchettone.  
Angle ball valve with fitting.

**585**

58534R	f	⊗
58534B	3/4"	5
5851R	3/4"	5
5851R	1"	5
5851B	1"	5



Cassetta d'ispezione per impianti a collettori **serie 607**.  
 Telaio a corpo unico e coperchio verniciato bianco RAL.  
 Cassetta in acciaio zincato con piede regolabile.  
 La confezione comprende il KIT viti e dadi per fissaggio staffe  
 collettori.

*Inspection cabinet for **items 607** manifold systems.  
 Monoblock frames and white RAL cover. The zincate steel  
 cabinet has adjustable feet. The package contains a fixing kit  
 with screws and nuts for mounting of the brackets.*

<b>670</b>	L	H	P	E
67040	400	600	110>150	110
67050	500	600	110>150	110
67060	600	600	110>150	110
67085	800	600	110>150	110
670100	1000	600	110>150	110

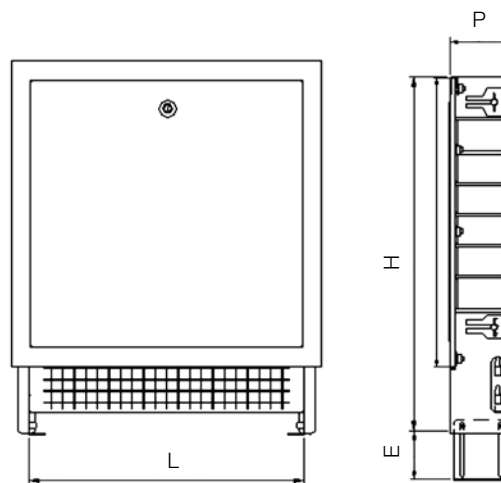



Cassetta per collettori di distribuzione con piedino regolabile incorporato. Verniciata bianca RAL 9010. Profondità regolabile: 110÷150.

*Metal cabinet for distribution manifolds with adjustable feet. White RAL 9010. Adjustable depth: 110÷150.*

<b>670</b>	<b>f</b> (LxHxP)	<b>☒</b>
67040	400 x 600 x 110÷150	1
67060	600 x 600 x 110÷150	1
67080	800 x 600 x 110÷150	1
670100	1000 x 600 x 110÷150	1
670120	1200 x 600 x 110÷150	1



Cassetta per collettori di distribuzione. Verniciata bianca RAL 9010. Profondità regolabile: 110÷150.

*Metal cabinet for distribution manifolds with adjustable frame. White RAL 9010. Adjustable depth: 110÷150.*

<b>675</b>	<b>f</b> (LxHxP)	<b>☒</b>
67540	400 x 450 x 110÷150	1
67560	600 x 450 x 110÷150	1
67580	800 x 450 x 110÷150	1
675100	1000 x 450 x 110÷150	1
675120	1200 x 450 x 110÷150	1



Coppia staffe metalliche per fissaggio collettori di distribuzione premontati **serie 607**.

*Couple of metal brackets for drawn distribution manifolds, items 607.*

<b>607S</b>	<b>f</b>	<b>☒</b>
6071S	1"	2
607114S	1"1/4	2



Coppia staffe metalliche per fissaggio collettori semplici **serie 600**.

*Couple of metal brackets for simple manifolds, items 600.*

<b>600S</b>	<b>f</b>	<b>☒</b>
600S	3/4"-1"	2

ATTACCO  
 3/4"  
 EUROCONO



ATTACCO  
 3/4"  
 EUROCONO



Raccordo 3/4" eurocono per tubo multistrato.

Compression fitting for multilayer pipe, connections 3/4" eurocone.

<b>755C</b>	<b>f</b>	<b>⊗</b>	<b>⊗</b>
75514C	14 x 2	50	250
75516C	16 x 2	50	250
755162C	16 x 2,25	50	250
75517C	17 x 2	50	250
75518C	18 x 2	50	250
75520C	20 x 2	50	250
75525C	20 x 2,5	50	250

Raccordo da 3/4" per tubo plastica.

Compression fitting for plastic pipe, connections 3/4" eurocone.

<b>756C</b>	<b>f</b>	<b>⊗</b>	<b>⊗</b>
75614C	14 x 2	50	250
75616C	16 x 2	50	250
75617C	17 x 2	50	250
75620C	20 x 2	50	250
75625C	20 x 2,5	50	250

ATTACCO  
 3/4"  
 EUROCONO



Raccordo 3/4" eurocono per tubo rame ogiva in gomma.

Compression fitting for copper pipe with rubber monocone, connections 3/4" eurocone.

<b>613</b>	<b>f</b>	<b>⊗</b>	<b>⊗</b>
61312	3/4" x 12	50	250
61314	3/4" x 14	50	250
61315	3/4" x 15	50	250
61316	3/4" x 16	50	250
61318	3/4" x 18	50	250

Chiave poligonale per calotte esagono 24 e 27 mm.

Polygon spanner mm 24 and 27 mm.

<b>637</b>	<b>f</b>	<b>⊗</b>
637	24-27	1

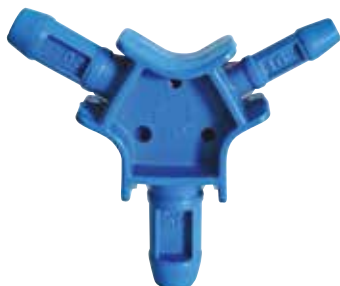

Svasatore per tubi Ø 16, 20, 26.

Reamer for pipes Ø 16, 20, 26.

<b>960</b>	<b>f</b>	<b>⊗</b>
960	Ø 16-20-26	5

**Sistema intercambiabile** per tubo rame, plastica e multistrato. **Interchangeable system** for copper, plastic and multilayer pipe.

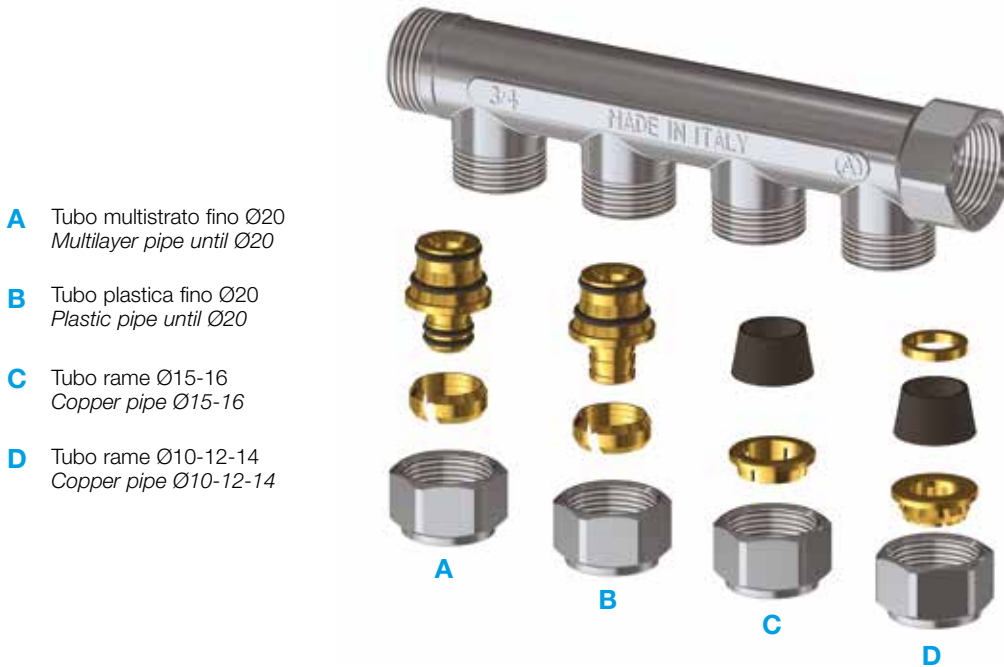

**A** Tubo multistrato fino Ø20  
*Multilayer pipe until Ø20*

**B** Tubo plastica fino Ø20  
*Plastic pipe until Ø20*

**C** Tubo rame Ø15-16  
*Copper pipe Ø15-16*

**D** Tubo rame Ø10-12-14  
*Copper pipe Ø10-12-14*



Raccordo a compressione per tubo rame,  
 monocono in gomma, calotta filetto 24x19 cromata.  
*Compression fitting connection for copper pipe.  
 Rubber monocone and chromium-plated brass nut thread 24x19.*

<b>720C</b>			
72010C	Ø10	50	250
72012C	Ø12	50	250
72014C	Ø14	50	250



Raccordo a compressione per tubo rame,  
 monocono in gomma, calotta filetto 24x19 cromata.  
*Compression fitting connection for copper pipe.  
 Rubber monocone and chromium-plated brass nut thread 24x19.*

<b>721C</b>			
72115C	Ø15	50	250
72116C	Ø16	50	250



Raccordo per tubo plastica, calotta filetto 24x19 cromata.  
*Fitting for plastic pipe.  
 Chromium-plated brass nut thread 24x19.*

<b>751C</b>			
75112C	12 x 2	50	250
75115C	15 x 2,5	50	250
75116C	16 x 2	50	250
75117C	17 x 2	50	250
75118C	18 x 2,5	50	250
75120C	20 x 2	50	250
75125C	20 x 2,5	50	250

Raccordo per tubo multistrato, calotta filetto 24x19 cromata.  
*Fitting for multilayer pipe.  
 Chromium-plated brass nut thread 24x19.*

<b>753C</b>			
75314C	14 x 2	50	250
75315C	15 x 2,5	50	250
75316C	16 x 2	50	250
753162C	16 x 2,25	50	250
753166C	16,2 x 2,6	50	250
753168C	16,8 x 2,5	50	250
75317C	17 x 2	50	250
753177C	17 x 2,7	50	250
75318C	18 x 2	50	250
75320C	20 x 2	50	250
753202C	20 x 2,25	50	250
75325C	20 x 2,5	50	250
75329C	20 x 2,9	50	250



Azionatore elettrotermico attacco M30 x 1,5.  
Alimentazione a 230 V. (Normalmente chiuso).

*Electrothermal actuator, connection M30 x 1,5.  
Voltage 230 V. (Normally closed).*

<b>315</b>	<b>f</b>	<b>⊗</b>	<b>⊗</b>
31523S	230 V - 4 fili	1	50
31623	230 V - 2 fili	1	50



Comando termostatico con sonda a distanza,  
limitazione temperatura del fluido 20°C ÷ 65°C.

*Thermostatic head with remote sensor limit temperature of the  
fluid from 20°C to 65°C.*

<b>314</b>	<b>f</b>	<b>⊗</b>	<b>⊗</b>
31412	M30 x 1,5	1	10



Valvola termostatica diritta con servocomando 230V.

*Thermostatic valve with motor 230V.*

<b>303S</b>	<b>f</b>	<b>⊗</b>	<b>⊗</b>
303S34	3/4"	1	5
303S1	1"	1	5



Valvola diritta cromata termostattabile.  
Attacco tubo ferro e codolo per collettore.

*Chromium-plated straight valve with thermostatic option.  
Connection for iron pipe and fitting for manifold.*

<b>303</b>	<b>f</b>	<b>⊗</b>
30334	3/4"	5
3031	1"	5



Detentore diritto cromato.  
Attacco tubo ferro e codolo per collettore.

*Chromium-plated straight lockshield.  
Connection for iron pipe and fitting for manifold.*

<b>230</b>	<b>f</b>	<b>⊗</b>
23034	3/4"	5
2301	1"	5



Valvola a sfera M/F.

*Ball valve M/F.*

<b>585S</b>	<b>f</b>	<b>⊗</b>
58534S	3/4" x 1"	5
5851S	1" x 1"1/4	5



Valvola a sfera.

*Ball valve.*

<b>584R</b>	<b>f</b>	<b>⊗</b>	<b>€</b>
58434R	3/4"	5	12,60
5841R	1"	5	21,50



Valvola a sfera ad angolo con bocchettone.

*Angle ball valve with fitting.*

<b>585</b>	<b>f</b>	<b>⊗</b>
58534R	3/4"	5
58534B	3/4"	5
5851R	1"	5
5851B	1"	5



Termometro bimetallico Ø40 - scala 0°÷80°C.  
Bimetallic thermometer Ø40 - range from 0° to 80°C.

<b>614</b>			
614	-		10
61412	1/2G		10



Gruppo premontato per collettori con valvola sfogo aria automatica, scarico girevole e termometro 0°÷80°C.

Manifold's pre-assembled group with automatic air vent valve, rotating discharging and thermometer from 0° to 80°C.

<b>615</b>			
615	1"	1	20



Terminale per collettori con valvola sfogo aria automatica e scarico girevole.

Manifold's terminal with automatic air vent valve and rotating discharging.

<b>616</b>			
61634	3/4"	1	20
6161	1"	1	20



Terminale per collettori con valvola sfogo aria manuale e scarico girevole.

Manifold's terminal with manual air vent valve and rotating discharging.

<b>617</b>			
61734	3/4"	1	20
6171	1"	1	20



Terminale per collettori con valvola sfogo aria automatica e rubinetto di scarico.

Manifold's terminal with automatic air vent valve and discharging.

<b>616E</b>			
616E34	3/4"	1	20
616E1	1"	1	20



Terminale per collettori con valvola sfogo aria manuale e rubinetto di scarico.

Manifold's terminal with manual air vent valve and discharging.

<b>617E</b>			
617E34	3/4"	1	20
617E1	1"	1	20



Valvola di scarico acqua  
Valve for water discharging.

<b>627</b>			
62712	1/2"		10



Valvola F/F ad incasso con cappuccio in ottone cromato.  
Set valve F/F with chromium-plated brass cap.

<b>628CR</b>			
628CR12	1/2"	1	10



Raccordo diritto M/M con O-ring per collettori serie 607.  
*Straight fitting M/M with O-ring for items 607.*

<b>626</b>		
6261	1"	1
626114	1"1/4	1



Chiave poligonale per calotte esagono 24 e 27 mm.  
*Polygon spanner for 24 and 27 mm hexagon nuts.*

<b>637</b>		
637	24-2750	1

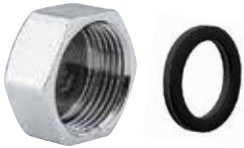

Tappo cieco cromato con guarnizione.  
*Chromium-plated end cap with seal.*

<b>620C</b>		
62012C	1/2"	50
62034C	3/4"	50
6201C	1"	50
620114C	1"1/4	50



Tappo maschio cromato con tenuta O-ring.  
*Chromium-plated male end cap with O-ring seal.*

<b>621C</b>		
62112C	1/2"	50
62134C	3/4"	50
6211C	1"	50
621114C	1 1/4"	50



Tappo cieco giallo filetto 24x19 con guarnizione di chiusura.  
*Yellow end cap thread 24x19 with closing seal.*

<b>623</b>		
623	24x19	50



Tappo cieco cromato filetto 24x19 con guarnizione di chiusura.  
*Chromium-plated end cap thread 24x19 with closing seal.*

<b>623C</b>		
623C	24x19	50





Tappo di testa maschio cromato con foro di riduzione.  
Chromium-plated male head cap with reduction.

<b>624C</b>	<b>F</b>	<b>⊗</b>
6243438C	3/4" x 3/8"	50
6243412C	3/4" x 1/2"	50
624138C	1" x 3/8"	50
624112C	1" x 1/2"	50
62411412C	1"1/4 x 1/2"	50
62411434C	1"1/4 x 3/4"	50
6241141C	1"1/4 x 1"	50



Tappo di testa femmina cromato con foro di riduzione.  
Chromium-plated female head cap with reduction.

<b>625C</b>	<b>F</b>	<b>⊗</b>
6253438C	3/4" x 3/8"	50
625138C	1" x 3/8"	50
625112C	1" x 1/2"	50



Tappo di testa maschio cromato con attacco per sfiato e scarico.  
Chromium-plated male head cap with two connection.

<b>717C</b>	<b>F</b>	<b>⊗</b>
71734C	3/4" x 3/8" x 1/2"	25
7171C	1" x 1/2" x 1/2"	25



Tappo di testa femmina cromato con attacco per sfiato e scarico.  
Chromium-plated female head cap with two connection.

<b>718C</b>	<b>F</b>	<b>⊗</b>
71834C	3/4" x 3/8" x 1/2"	25
7181C	1" x 1/2" x 1/2"	25



Tappo di testa femmina giallo con attacco per sfiato.  
Yellow female head cap with discharging connection.

<b>719</b>	<b>F</b>	<b>⊗</b>
7193438	3/4" x 3/8"	25
7193412	3/4" x 1/2"	25
719138	1" x 3/8"	25
719112	1" x 1/2"	25



Tappo di testa femmina cromato con attacco per sfiato.  
Chromium-plated female head cap with discharging connection.

<b>719C</b>	<b>F</b>	<b>⊗</b>
7193438C	3/4" x 3/8"	25
7193412C	3/4" x 1/2"	25
719138C	1" x 3/8"	25
719112C	1" x 1/2"	25

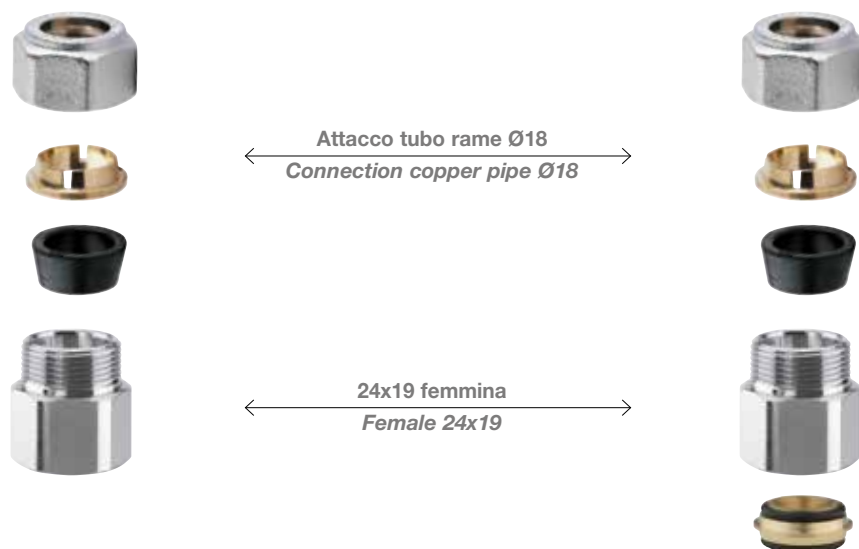

Prolunga cromata filetto 24x19 femmina ad attacco tubo rame Ø18.  
Female fitting thread 24x19, connection for copper pipe Ø18.  
Chromium-plated.

<b>853</b>				
85318G	24x19F - Ø18	30 mm	25	

Prolunga cromata filetto 24x19 femmina ad attacco tubo rame Ø18 con ogiva di tenuta.  
Female fitting thread 24x19, connection for copper pipe Ø18 with seal. Chromium-plated.

<b>863</b>				
86318G	24x19F - Ø18	30 mm	25	

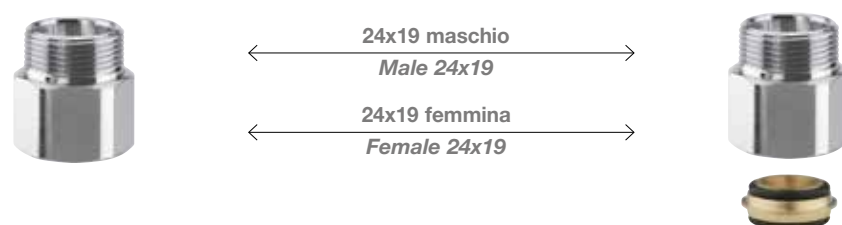

Prolunga cromata filetto 24x19 M/F.  
Attacco tubo rame, plastica e multistrato.  
Chromium fitting thread 24x19 M/F.  
Connection for copper, plastic and multilayer pipe.

<b>855</b>				
85524	24x19 M/F	30 mm	25	

Prolunga cromata filetto 24x19 M/F con ogiva di tenuta.  
Attacco tubo rame, plastica e multistrato.  
Chromium fitting thread 24x19 M/F with seal.  
Connection for copper, plastic and multilayer pipe.

<b>865</b>				
86524	24x19 M/F	30 mm	25	

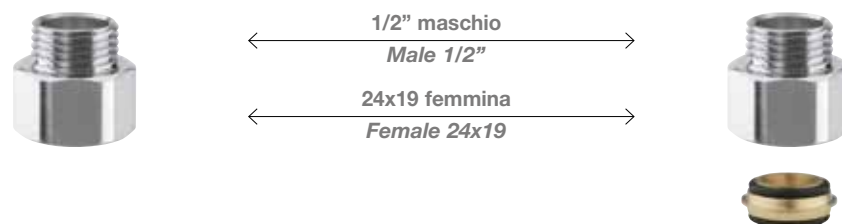

Adattatore cromato da filetto 24x19 ad attacco 1/2" gas maschio.  
Chromium fitting reduction 24x19 for male 1/2" gas connection.

<b>857</b>				
85724	24x19F-1/2"M	30 mm	25	

Adattatore cromato da filetto 24x19 ad attacco 1/2" gas maschio con ogiva di tenuta.  
Chromium fitting reduction 24x19 for male 1/2" gas connection with seal.

<b>867</b>				
86724	24x19F-1/2"M	30 mm	25	



Manopola, dischetti e vite per collettori serie 639.

Handwheel, disks and screw for manifolds items 639.

<b>644</b>	<input checked="" type="checkbox"/>	<input checked="" type="checkbox"/>
644	-	1



Manopola, dischetti e vite per collettori serie 640.

Handwheel, disks and screw for manifolds items 640.

<b>647</b>	<input checked="" type="checkbox"/>	<input checked="" type="checkbox"/>
647	-	1



Manopola in ABS bianco per collettori serie 639.

White ABS handwheel for manifolds items 639.

<b>643</b>	<input checked="" type="checkbox"/>	<input checked="" type="checkbox"/>
643	-	10



Manopola in ABS bianco per collettori serie 640.

White ABS handwheel for manifolds items 640.

<b>646</b>	<input checked="" type="checkbox"/>	<input checked="" type="checkbox"/>
646	-	10

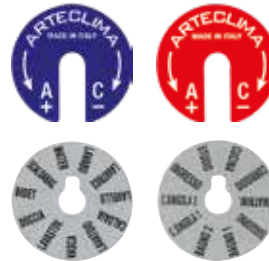

Coppia dischetti doppia faccia in alluminio serigrafato.

Couple of serigraphied aluminium double face disks.

<b>645</b>	<input checked="" type="checkbox"/>	<input checked="" type="checkbox"/>
645	-	10



Vite cromata per manopole collettori.

Chromium-plated screw for manifold handwheels.

<b>3190</b>	<input checked="" type="checkbox"/>	<input checked="" type="checkbox"/>
3190	3/16W	50



Vitone per collettori serie 640.

Screw stem for manual manifolds items 640.

<b>648</b>	<input checked="" type="checkbox"/>	<input checked="" type="checkbox"/>
64838	3/8"	10



Vitone per collettori serie 639.

Screw stem for manual manifolds items 639.

<b>649</b>	<input checked="" type="checkbox"/>	<input checked="" type="checkbox"/>
64938	3/8"	10



Vitone per collettori serie 607.

Screw stem for manifolds items 607.

<b>3172</b>	<input checked="" type="checkbox"/>	<input checked="" type="checkbox"/>
3172	1/2"	10



Regolatore e misuratore di portata 0,5÷5 l/min.

Regulator and flow meter 0,5÷5 l/min.

<b>3174</b>	<input checked="" type="checkbox"/>	<input checked="" type="checkbox"/>
3174	1/2"	10



Vitone termostatico per collettori serie 607.

Screw stem with thermostatic option for manifolds items 607.

<b>3171</b>	<input checked="" type="checkbox"/>	<input checked="" type="checkbox"/>
3171	1/2"-30 x 1,5	10



Cappuccio manuale in ABS bianco.

White ABS manual cap.

<b>3170</b>	<input checked="" type="checkbox"/>	<input checked="" type="checkbox"/>
3170	-	10



## Raccordi

Raccordi GAS	152
Raccordi curvi attacco tubo rame, plastica e multistrato	154
Raccordi a "T" attacco tubo rame, plastica e multistrato	155
Raccordi dritti attacco tubo rame, plastica e multistrato	156
Adattatori filetto 24x19 per tubi a pressare	157
Raccordi per tubo rame, plastica e multistrato	158
Raccordi completi per tubo multistrato	160
Raccordi completi per tubo rame	165
Accessori e ricambi	169
Raccordi tre pezzi	170

## Fittings

<i>Fittings for GAS</i>	152
<i>Elbow fittings, connection for copper, plastic and multilayer pipe</i>	154
<i>Tee fittings, connection for copper, plastic and multilayer pipe</i>	155
<i>Straight fittings connection for copper, plastic and multilayer pipe</i>	156
<i>Fittings for press pipe, connection 24x19</i>	157
<i>Fittings for copper, plastic and multilayer pipe</i>	158
<i>Complete fittings for multilayer pipe</i>	160
<i>Complete fittings for copper pipe</i>	165
<i>Spare-parts</i>	169
<i>Three pieces connections</i>	170



Linea di raccordi meccanici per impianti Gas e idrocarburi fluidi adatti all'utilizzo su tubi in rame di diametro 12, 14, 15, 16, 18 e 22 mm.

*Line of mechanic fittings for Gas and hydrocarbon fluids, suitable for use on copper pipe with a diameter 12, 14, 15, 16, 18 e 22 mm.*

Conforme alle norme:

UNI EN 1254-2

UNI EN 1254-4

UNI EN 682

According to:

UNI EN 1254-2

UNI EN 1254-4

UNI EN 682

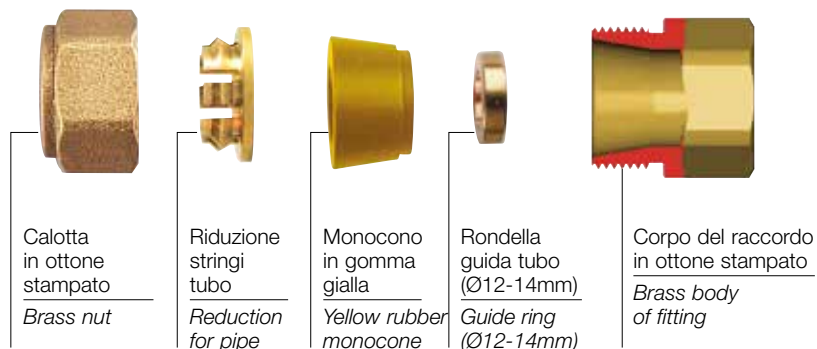

Calotta in ottone stampato  
Brass nut

Riduzione stringi tubo  
Reduction for pipe

Monocono in gomma gialla  
Yellow rubber monocone

Rondella guida tubo (Ø12-14mm)  
Guide ring (Ø12-14mm)

Corpo del raccordo in ottone stampato  
Brass body of fitting

## ISTRUZIONI DI MONTAGGIO

- Tagliare e sbavare il tubo
- Inserire calotta e riduzione stringi-tubo
- Inserire il monocono in gomma gialla e l'eventuale rondella
- Posizionare il tubo con il kit nella sede conica allineandolo al corpo del raccordo
- Serrare la calotta.

### NOTA IMPORTANTE



Per installare questa tipologia di raccordo si devono seguire le istruzioni riportate nella Norma UNI 7129 e UNI 7131.

## ASSEMBLY INSTRUCTIONS

- Cut and trim the pipe
- Insert the nut and reduction pipe
- Insert the yellow rubber monocone and the guide ring
- Put the pipe with the kit in the cone side, body fitting alignment
- Tighten the nut.



### IMPORTANT NOTE

To install this type of fitting you have to follow the instructions of UNI 7129 and UNI 7131.

## CARATTERISTICHE TECNICHE

- Pressione nominale: 10 bar
- Temperatura di esercizio: -15°C - + 50°C
- Fluidi utilizzabili: Gas e idrocarburi fluidi.

## TECHNICAL DATA

- Nominal pression: 10 bar
- Operating temperature: -15°C - + 50°C
- Usable fluids: Gas and hydrocarbon.



Niplex maschio completo di kit di tenuta per tubo rame adatto per il trasporto di gas e idrocarburi fluidi.

Conforme alle norme UNI EN 1254-4 e UNI EN 682.

*Male nipples with seal kit for copper pipe, fit for the transport of Gas and hydrocarbon fluids.*

According to UNI EN 1254-4 and UNI EN 682.

## 904

	f	×	⊗
9043812	3/8" x 12	25	125
9043814	3/8" x 14	25	125
9041212	1/2" x 12	25	125
9041214	1/2" x 14	25	125
9041215	1/2" x 15	25	125
9041216	1/2" x 16	25	125
9041218	1/2" x 18	25	125
9043416	3/4" x 16	25	125
9043418	3/4" x 18	25	125
9043422	3/4" x 22	25	125
904122	1" x 22	10	50



Niplex femmina completo di kit di tenuta per tubo rame adatto per il trasporto di gas e idrocarburi fluidi.

Conforme alle norme UNI EN 1254-4 e UNI EN 682.

*Female nipples with seal kit for copper pipe, fit for the transport of Gas and hydrocarbon fluids.*

According to UNI EN 1254-4 and UNI EN 682.

## 908

	f	×	⊗
9083812	3/8" x 12	25	125
9083814	3/8" x 14	25	125
9081212	1/2" x 12	25	125
9081214	1/2" x 14	25	125
9081215	1/2" x 15	25	125
9081216	1/2" x 16	25	125
9081218	1/2" x 18	25	125
9083416	3/4" x 16	25	125
9083418	3/4" x 18	25	125
9083422	3/4" x 22	25	125
908122	1" x 22	10	50

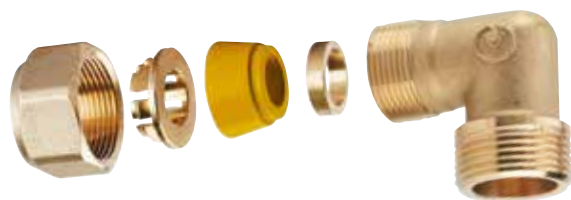

Gomito maschio completo di kit di tenuta per tubo rame adatto per il trasporto di gas e idrocarburi fluidi.  
Conforme alle norme UNI EN 1254-4 e UNI EN 682.

*Male elbow with seal kit for copper pipe, fit for the transport of Gas and hydrocarbon fluids.  
According to UNI EN 1254-4 and UNI EN 682.*

<b>914</b>	<b>f</b>	<b>⊗</b>	<b>⊗</b>
9141212	1/2" x 12	25	125
9141214	1/2" x 14	25	125
9141215	1/2" x 15	25	125
9141216	1/2" x 16	25	125
9141218	1/2" x 18	25	125
9143416	3/4" x 16	25	125
9143418	3/4" x 18	25	125
9143422	3/4" x 22	10	50
914122	1" x 22	10	50



Gomito femmina completo di kit di tenuta per tubo rame adatto per il trasporto di gas e idrocarburi fluidi.  
Conforme alle norme UNI EN 1254-4 e UNI EN 682.

*Female elbow with seal kit for copper pipe, fit for the transport of Gas and hydrocarbon fluids.  
According to UNI EN 1254-4 and UNI EN 682.*

<b>912</b>	<b>f</b>	<b>⊗</b>	<b>⊗</b>
9121212	1/2" x 12	25	125
9121214	1/2" x 14	25	125
9121215	1/2" x 15	25	125
9121216	1/2" x 16	25	125
9121218	1/2" x 18	25	125
9123416	3/4" x 16	25	125
9123418	3/4" x 18	25	125
9123422	3/4" x 22	10	50
912122	1" x 22	10	50



Raccordo a muro completo di kit di tenuta per tubo rame adatto per il trasporto di gas e idrocarburi fluidi.  
Conforme alle norme UNI EN 1254-4 e UNI EN 682.

*Wall mounted connection with seal kit for copper pipe, fit for the transport of Gas and hydrocarbon fluids.  
According to UNI EN 1254-4 and UNI EN 682.*

<b>920</b>	<b>f</b>	<b>⊗</b>	<b>⊗</b>
9201212	1/2" x 12	25	125
9201214	1/2" x 14	25	125
9201215	1/2" x 15	25	125
9201216	1/2" x 16	25	125
9201218	1/2" x 18	25	125



Kit di tenuta per raccordi meccanici adatto per il trasporto di gas e idrocarburi fluidi. Conforme alle norme UNI EN 682.  
**Installabile unicamente con gli articoli 704 - 708 - 802 - 804 - 812 - 814 - 820.**

*Kit for mechanic fittings, fit for the transport of Gas and hydrocarbon fluids. According to UNI EN 682.*

**Only possible to install with the items 704 - 708 - 802 - 804 - 812 - 814 - 820.**

<b>923</b>	<b>f</b>	<b>⊗</b>	<b>⊗</b>
92312	Ø 12	50	250
92314	Ø 14	50	250
92315	Ø 15	50	250
92316	Ø 16	50	250



Raccordo curvo in ottone giallo.  
 Attacchi tubo rame, plastica e multistrato.

*Yellow brass elbow fitting, connection for copper, plastic and multilayer pipe.*

<b>810</b>			
81012	24x19	25	125

Raccordo curvo in ottone cromato.  
 Attacchi tubo rame, plastica e multistrato.

*Chromium brass elbow fitting, connection for copper, plastic and multilayer pipe.*

<b>811</b>			
81112	24x19	25	125



Raccordo curvo maschio in ottone giallo.  
 Attacco tubo rame, plastica e multistrato.

*Yellow brass male elbow fitting, connection for copper, plastic and multilayer pipe.*

<b>814</b>			
81412	1/2"	25	125
81434	3/4"	25	125

Raccordo curvo maschio in ottone cromato.  
 Attacco tubo rame, plastica e multistrato.

*Chromium brass male elbow fitting, connection for copper, plastic and multilayer pipe.*

<b>815</b>			
81512	1/2"	25	125
81534	3/4"	25	125



Raccordo curvo femmina in ottone giallo.  
 Attacco tubo rame, plastica e multistrato.

*Yellow brass female elbow fitting, connection for copper, plastic and multilayer pipe.*

<b>812</b>			
81212	1/2"	25	125
81234	3/4"	25	125

Raccordo curvo femmina in ottone cromato.  
 Attacco tubo rame, plastica e multistrato.

*Chromium brass female elbow fitting, connection for copper, plastic and multilayer pipe.*

<b>813</b>			
81312	1/2"	25	125
81334	3/4"	25	125



Raccordo curvo femmina flangiato in ottone giallo.  
 Attacco tubo rame, plastica e multistrato.

*Yellow brass female wall bearing elbow fitting, connection for copper, plastic and multilayer pipe.*

<b>820</b>			
82012	1/2"	25	125

Raccordo curvo femmina flangiato in ottone cromato.  
 Attacco tubo rame, plastica e multistrato.

*Chromium brass female wall bearing elbow fitting, connection for copper, plastic and multilayer pipe.*

<b>821</b>			
82112	1/2"	25	125





Raccordo a "T" in ottone giallo con tre attacchi tubo rame, plastica e multistrato.

*Yellow brass tee fitting with three connections for copper, plastic and multilayer pipe.*

<b>800</b>			
80012	24x19	25	125



Raccordo a "T" in ottone cromato con tre attacchi tubo rame, plastica e multistrato.

*Chromium brass tee fitting with three connections for copper, plastic and multilayer pipe.*

<b>801</b>			
80112	24x19	25	125



Raccordo a "T" femmina in ottone giallo con due attacchi tubo rame, plastica e multistrato.

*Yellow brass female tee fitting with two connections for copper, plastic and multilayer pipe.*

<b>802</b>			
80212	1/2"	25	125
80234	3/4"	25	125



Raccordo a "T" femmina in ottone cromato con due attacchi tubo rame, plastica e multistrato.

*Chromium brass female tee fitting with two connections for copper, plastic and multilayer pipe.*

<b>803</b>			
80312	1/2"	25	125
80334	3/4"	25	125



Raccordo a "T" maschio in ottone giallo con due attacchi tubo rame, plastica e multistrato.

*Yellow brass male tee fitting with two connections for copper, plastic and multilayer pipe.*

<b>804</b>			
80412	1/2"	25	125
80434	3/4"	25	125



Raccordo a "T" maschio in ottone cromato con due attacchi tubo rame, plastica e multistrato.

*Chromium brass male tee fitting with two connections for copper, plastic and multilayer pipe.*

<b>805</b>			
80512	1/2"	25	125
80534	3/4"	25	125



Raccordo a "T" maschio in ottone giallo con due attacchi tubo rame, plastica e multistrato.

*Yellow brass male tee fitting with two connections for copper, plastic and multilayer pipe.*

<b>806</b>			
80612	1/2"	25	125



Raccordo a "T" maschio in ottone cromato con due attacchi tubo rame, plastica e multistrato.

*Chromium brass male tee fitting with two connections for copper, plastic and multilayer pipe.*

<b>807</b>			
80712	1/2"	25	125



Niplex maschio in ottone giallo.  
 Attacco tubo rame, plastica e multistrato.

*Yellow brass male fitting connection for copper, plastic and multilayer pipe.*

<b>704</b>	<b>f</b>	<b>⊠</b>	<b>⊞</b>
70438	3/8"	50	250
70412	1/2"	50	250
70434	3/4"	50	250
7041	1"	25	125



Niplex maschio in ottone cromato.  
 Attacco tubo rame, plastica e multistrato.

*Chromium brass male fitting connection for copper, plastic and multilayer pipe.*

<b>705</b>	<b>f</b>	<b>⊠</b>	<b>⊞</b>
70538	3/8"	50	250
70512	1/2"	50	250
70534	3/4"	50	250
7051	1"	25	125



Niplex femmina in ottone giallo.  
 Attacco tubo rame, plastica e multistrato.

*Yellow brass female fitting connection for copper, plastic and multilayer pipe.*

<b>708</b>	<b>f</b>	<b>⊠</b>	<b>⊞</b>
70838	3/8"	50	250
70812	1/2"	50	250
70834	3/4"	50	250
7081	1"	25	125



Niplex femmina in ottone cromato.  
 Attacco tubo rame, plastica e multistrato.

*Chromium brass female fitting connection for copper, plastic and multilayer pipe.*

<b>709</b>	<b>f</b>	<b>⊠</b>	<b>⊞</b>
70938	3/8"	50	250
70912	1/2"	50	250
70934	3/4"	50	250
7091	1"	25	125



Niplex doppio in ottone giallo.  
 Attacchi tubo rame, plastica e multistrato.

*Yellow brass double fitting connection for copper, plastic and multilayer pipe.*

<b>710</b>	<b>f</b>	<b>⊠</b>	<b>⊞</b>
71012	24x19	50	250



Niplex doppio in ottone cromato.  
 Attacchi tubo rame, plastica e multistrato.

*Chromium brass double fitting connection for copper, plastic and multilayer pipe.*

<b>711</b>	<b>f</b>	<b>⊠</b>	<b>⊞</b>
71112	24x19	50	250

**ATTACCO 24x19**  
 24x19 CONNECTION



Raccordo Arteclima attacco 24x19 a pressione.  
*Arteclima's press fitting, connection 24x19.*

<b>964</b>	<b>f</b>	<b>⊗</b>
96416	24x19 - 16 x 2	20
96420	24x19 - 20 x 2	20

**ATTACCO 24x19**  
 24x19 CONNECTION



Raccordo Arteclima cromato attacco 24x19 a pressione.  
*Chromium-plated Arteclima's press fitting, connection 24x19.*

<b>965</b>	<b>f</b>	<b>⊗</b>
96516	24x19 - 16 x 2	20
96520	24x19 - 20 x 2	20

**Compatibile con pinze TH - H - U**  
**Suitable for TH - H - U tongs**



Svasatore per tubi Ø 16, 20, 26.  
*Reamer for pipes Ø 16, 20, 26.*

<b>960</b>	<b>f</b>	<b>⊗</b>
960	Ø 16-20-26	5

**Sistema intercambiabile** per tubo rame, plastica e multistrato. **Interchangeable system** for copper, plastic and multilayer pipe.

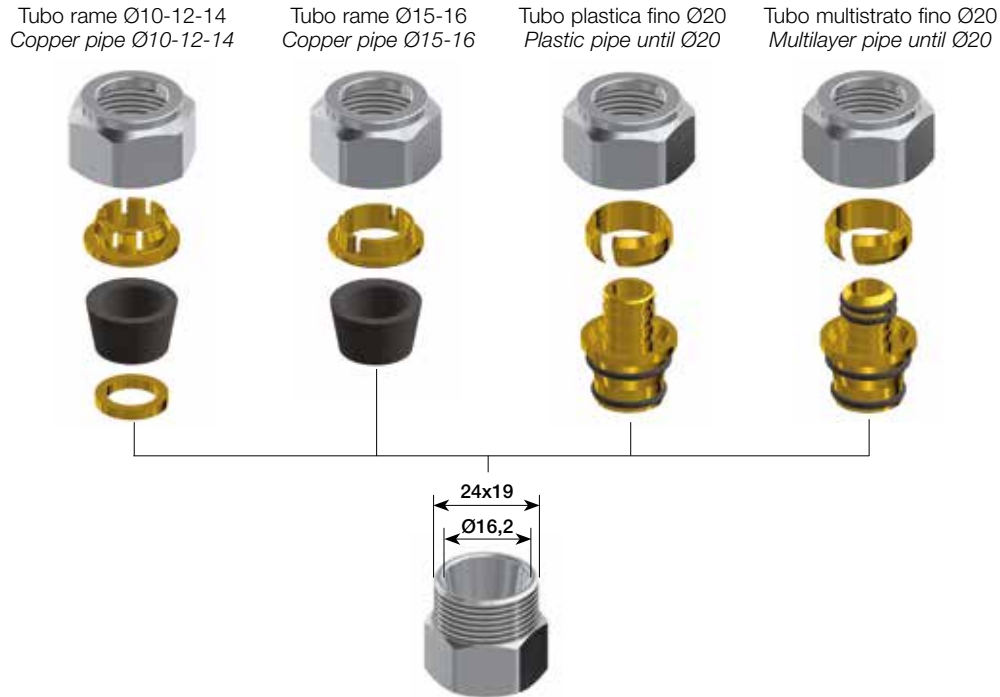

**CARATTERISTICHE TECNICHE**

- Calotta ES.27 ottone CW 617N, Norma UNI EN 12165
  - Guarnizioni EPDM perossido, norma UNI EN 681-1, **(non adatte in presenza di oli minerali e idrocarburi)**
- Adattatori anelli, serratubi ottone CW614N, norma UNI EN12164
- Fluido d'impiego: acqua (anche potabile), soluzioni glicolate Max 30%
- Pressione massima d'esercizio: 12 bar
- Campo di temperatura: -20°C ÷ +110°C.

**TECHNICAL DATA**

- Nut of CW 617N brass, according to UNI EN 12165
  - EPDM peroxide O-ring, according to UNI EN 681-1, **(not in presence of mineral oil and hydrocarbon)**
- Adapter, ring, pipe lock of CW614N brass, according to UNI EN12164
- Working fluid: water (also potable), glycol fluid Max 30%
- Max operating pressure: 12 bar
- Temperature range: from -20°C to +110°C.



Raccordo a compressione per tubo rame monocono in gomma.  
 Calotta filetto 24x19 gialla.

*Compression fitting connection for copper pipe.  
 Rubber monocone and yellow brass nut thread 24x19.*

<b>720</b>			
72010	Ø10	50	250
72012	Ø12	50	250
72014	Ø14	50	250



Raccordo a compressione per tubo rame monocono in gomma.  
 Calotta filetto 24x19 cromata.

*Compression fitting connection for copper pipe.  
 Rubber monocone and chromium-plated brass nut thread 24x19.*

<b>720C</b>			
72010C	Ø10	50	250
72012C	Ø12	50	250
72014C	Ø14	50	250



Raccordo a compressione per tubo rame monocono in gomma.  
 Calotta filetto 24x19 gialla.

*Compression fitting connection for copper pipe.  
 Rubber monocone and yellow brass nut thread 24x19.*

<b>721</b>			
72115	Ø15	50	250
72116	Ø16	50	250



Raccordo a compressione per tubo rame monocono in gomma.  
 Calotta filetto 24x19 cromata.

*Compression fitting connection for copper pipe.  
 Rubber monocone and chromium-plated brass nut thread 24x19.*

<b>721C</b>			
72115C	Ø15	50	250
72116C	Ø16	50	250



Raccordo per tubo plastica. Calotta filetto 24x19 gialla.  
*Fitting for plastic pipe. Yellow brass nut thread 24x19.*

<b>751</b>			
75112	12 x 2	50	250
75115	15 x 2,5	50	250
75116	16 x 2	50	250
75117	17 x 2	50	250
75118	18 x 2,5	50	250
75120	20 x 2	50	250
75125	20 x 2,5	50	250



Raccordo per tubo plastica, calotta filetto 24x19 cromata.  
*Fitting for plastic pipe. Chromium-plated brass nut thread 24x19.*

<b>751C</b>			
75112C	12 x 2	50	250
75115C	15 x 2,5	50	250
75116C	16 x 2	50	250
75117C	17 x 2	50	250
75118C	18 x 2,5	50	250
75120C	20 x 2	50	250
75125C	20 x 2,5	50	250



Raccordo per tubo multistrato. Calotta filetto 24x19 gialla.  
*Fitting for multilayer pipe.  
 Yellow brass nut thread 24x19.*

<b>753</b>			
75314	14 x 2	50	250
75315	15 x 2,5	50	250
75316	16 x 2	50	250
753162	16 x 2,25	50	250
753166	16,2 x 2,6	50	250
753168	16,8 x 2,5	50	250
75317	17 x 2	50	250
753177	17 x 2,7	50	250
75318	18 x 2	50	250
75320	20 x 2	50	250
753202	20 x 2,25	50	250
75325	20 x 2,5	50	250
75329	20 x 2,9	50	250



Raccordo per tubo multistrato, calotta filetto 24x19 cromata.  
*Fitting for multilayer pipe.  
 Chromium-plated brass nut thread 24x19.*

<b>753C</b>			
75314C	14 x 2	50	250
75315C	15 x 2,5	50	250
75316C	16 x 2	50	250
753162C	16 x 2,25	50	250
753166C	16,2 x 2,6	50	250
753168C	16,8 x 2,5	50	250
75317C	17 x 2	50	250
753177C	17 x 2,7	50	250
75318C	18 x 2	50	250
75320C	20 x 2	50	250
753202C	20 x 2,25	50	250
75325C	20 x 2,5	50	250
75329C	20 x 2,9	50	250



Raccordo curvo doppio per tubo multistrato in ottone giallo.  
Yellow brass elbow fitting connection for multilayer pipe.

810M	f	∅	⊗	⊗
8101214M	14x2	14x2	25	125
8101216M	16x2	16x2	25	125
81012162M	16x2,25	16x2,25	25	125
8101220M	20x2	20x2	25	125
81012205M	20x2,5	20x2,5	25	125
810126M	26x3	26x3	10	50



Raccordo curvo doppio per tubo multistrato in ottone cromato.  
Chromium brass elbow fitting connection for multilayer pipe.

811M	f	∅	⊗	⊗
8111214M	14x2	14x2	25	125
8111216M	16x2	16x2	25	125
81112162M	16x2,25	16x2,25	25	125
8111220M	20x2	20x2	25	125
81112205M	20x2,5	20x2,5	25	125
811126M	26x3	26x3	10	50



Raccordo curvo femmina per tubo multistrato in ottone giallo.  
Yellow brass female elbow fitting connection for multilayer pipe.

812M	f	∅	⊗	⊗
8121214M	1/2"	14x2	25	125
8121216M	1/2"	16x2	25	125
81212162M	1/2"	16x2,25	25	125
8121220M	1/2"	20x2	25	125
81212205M	1/2"	20x2,5	25	125
8123414M	3/4"	14x2	25	125
8123416M	3/4"	16x2	25	125
81234162M	3/4"	16x2,25	25	125
8123420M	3/4"	20x2	25	125
81234205M	3/4"	20x2,5	25	125
8123426M	3/4"	26x3	10	50



Raccordo curvo femmina per tubo multistrato in ottone cromato.  
Chromium brass female elbow fitting connection for multilayer pipe.

813M	f	∅	⊗	⊗
8131214M	1/2"	14x2	25	125
8131216M	1/2"	16x2	25	125
81312162M	1/2"	16x2,25	25	125
8131220M	1/2"	20x2	25	125
81312205M	1/2"	20x2,5	25	125
8133414M	3/4"	14x2	25	125
8133416M	3/4"	16x2	25	125
81334162M	3/4"	16x2,25	25	125
8133420M	3/4"	20x2	25	125
81334205M	3/4"	20x2,5	25	125
8133426M	3/4"	26x3	10	50



Raccordo curvo M per tubo multistrato in ottone giallo.

*Yellow brass male elbow fitting connection for multilayer pipe.*

<b>814M</b>	<b>f</b>	<b>Ø</b>	<b>⊗</b>	<b>⊗</b>
8141214M	1/2"	14x2	25	125
8141216M	1/2"	16x2	25	125
81412162M	1/2"	16x2,25	25	125
8141220M	1/2"	20x2	25	125
81412205M	1/2"	20x2,5	25	125
8143414M	3/4"	14x2	25	125
8143416M	3/4"	16x2	25	125
81434162M	3/4"	16x2,25	25	125
8143420M	3/4"	20x2	25	125
81434205M	3/4"	20x2,5	25	125
8143426M	3/4"	26x3	10	50
814126M	1"	26x3	10	50



Raccordo curvo M per tubo multistrato in ottone cromato.

*Chromium brass male elbow fitting connection for multilayer pipe.*

<b>815M</b>	<b>f</b>	<b>Ø</b>	<b>⊗</b>	<b>⊗</b>
8151214M	1/2"	14x2	25	125
8151216M	1/2"	16x2	25	125
81512162M	1/2"	16x2,25	25	125
8151220M	1/2"	20x2	25	125
81512205M	1/2"	20x2,5	25	125
8153414M	3/4"	14x2	25	125
8153416M	3/4"	16x2	25	125
81534162M	3/4"	16x2,25	25	125
8153420M	3/4"	20x2	25	125
81534205M	3/4"	20x2,5	25	125
8153426M	3/4"	26x3	10	50
815126M	1"	26x3	10	50



Raccordo curvo F flangiato per tubo multistrato in ottone giallo.

*Yellow brass female wall bearing elbow fitting connection for multilayer pipe.*

<b>820M</b>	<b>f</b>	<b>Ø</b>	<b>⊗</b>	<b>⊗</b>
8201214M	1/2"	14x2	20	100
8201216M	1/2"	16x2	20	100
82012162M	1/2"	16x2,25	20	100
8201220M	1/2"	20x2	20	100
82012205M	1/2"	20x2,5	20	100



Raccordo curvo F flangiato per tubo multistrato in ottone cromato.

*Chromium brass female wall bearing elbow fitting connection for multilayer pipe.*

<b>821M</b>	<b>f</b>	<b>Ø</b>	<b>⊗</b>	<b>⊗</b>
8211214M	1/2"	14x2	20	100
8211216M	1/2"	16x2	20	100
82112162M	1/2"	16x2,25	20	100
8211220M	1/2"	20x2	20	100
82112205M	1/2"	20x2,5	20	100



Raccordo nipleo doppio per tubo multistrato in ottone giallo.  
Yellow brass double fitting connection for multilayer pipe.

Raccordo nipleo doppio per tubo multistrato in ottone cromato.  
Chromium brass double fitting connection for multilayer pipe.

<b>710M</b>				
7101214M	14x2	14x2	25	125
7101216M	16x2	16x2	25	125
71012162M	16x2,25	16x2,25	25	125
7101220M	20x2	20x2	25	125
71012205M	20x2,5	20x2,5	25	125
710126M	26X3	26X3	10	50

<b>711M</b>				
7111214M	14x2	14x2	25	125
7111216M	16x2	16x2	25	125
71112162M	16x2,25	16x2,25	25	125
7111220M	20x2	20x2	25	125
71112205M	20x2,5	20x2,5	25	125
711126M	26X3	26X3	10	50



Raccordo nipleo femmina per tubo multistrato in ottone giallo.  
Yellow brass female fitting connection for multilayer pipe.

Raccordo nipleo femmina per tubo multistrato in ottone cromato.  
Chromium brass female fitting connection for multilayer pipe.

<b>708M</b>				
7083814M	3/8"	14x2	25	125
7083816M	3/8"	16x2	25	125
70838162M	3/8"	16x2,25	25	125
7083820M	3/8"	20x2	25	125
70838205M	3/8"	20x2,5	25	125
7081214M	1/2"	14x2	25	125
7081216M	1/2"	16x2	25	125
70812162M	1/2"	16x2,25	25	125
7081220M	1/2"	20x2	25	125
70812205M	1/2"	20x2,5	25	125
7083414M	3/4"	14x2	25	125
7083416M	3/4"	16x2	25	125
70834162M	3/4"	16x2,25	25	125
7083420M	3/4"	20x2	25	125
70834205M	3/4"	20x2,5	25	125
7083426M	3/4"	26x3	10	50
708116M	1"	16x2	25	125
7081162M	1"	16x2,25	25	125
708120M	1"	20x2	25	125
7081205M	1"	20x2,5	25	125
708126M	1"	26x3	10	50

<b>709M</b>				
7093814M	3/8"	14x2	25	125
7093816M	3/8"	16x2	25	125
70938162M	3/8"	16x2,25	25	125
7093820M	3/8"	20x2	25	125
70938205M	3/8"	20x2,5	25	125
7091214M	1/2"	14x2	25	125
7091216M	1/2"	16x2	25	125
70912162M	1/2"	16x2,25	25	125
7091220M	1/2"	20x2	25	125
70912205M	1/2"	20x2,5	25	125
7093414M	3/4"	14x2	25	125
7093416M	3/4"	16x2	25	125
70934162M	3/4"	16x2,25	25	125
7093420M	3/4"	20x2	25	125
70934205M	3/4"	20x2,5	25	125
7093426M	3/4"	26x3	10	50
709116M	1"	16x2	25	125
7091162M	1"	16x2,25	25	125
709120M	1"	20x2	25	125
7091205M	1"	20x2,5	25	125
709126M	1"	26x3	10	50





Raccordo niplex maschio per tubo multistrato in ottone giallo.  
Yellow brass male fitting connection for multilayer pipe.

<b>704M</b>	<b>f</b>	<b>∅</b>	<b>⊗</b>	<b>⊗</b>
7043814M	3/8"	14x2	25	125
7043816M	3/8"	16x2	25	125
70438162M	3/8"	16x2,25	25	125
7043820M	3/8"	20x2	25	125
70438205M	3/8"	20x2,5	25	125
7041214M	1/2"	14x2	25	125
7041216M	1/2"	16x2	25	125
70412162M	1/2"	16x2,25	25	125
7041220M	1/2"	20x2	25	125
70412205M	1/2"	20x2,5	25	125
7043414M	3/4"	14x2	25	125
7043416M	3/4"	16x2	25	125
70434162M	3/4"	16x2,25	25	125
7043420M	3/4"	20x2	25	125
70434205M	3/4"	20x2,5	25	125
7043426M	3/4"	26x3	10	50
704116M	1"	16x2	25	125
7041162M	1"	16x2,25	25	125
704120M	1"	20x2	25	125
7041205M	1"	20x2,5	25	125
704126M	1"	26x3	10	50



Raccordo niplex maschio per tubo multistrato in ottone cromato.  
Chromium brass male fitting connection for multilayer pipe.

<b>705M</b>	<b>f</b>	<b>∅</b>	<b>⊗</b>	<b>⊗</b>
7053814M	3/8"	14x2	25	125
7053816M	3/8"	16x2	25	125
70538162M	3/8"	16x2,25	25	125
7053820M	3/8"	20x2	25	125
70538205M	3/8"	20x2,5	25	125
7051214M	1/2"	14x2	25	125
7051216M	1/2"	16x2	25	125
70512162M	1/2"	16x2,25	25	125
7051220M	1/2"	20x2	25	125
70512205M	1/2"	20x2,5	25	125
7053414M	3/4"	14x2	25	125
7053416M	3/4"	16x2	25	125
70534162M	3/4"	16x2,25	25	125
7053420M	3/4"	20x2	25	125
70534205M	3/4"	20x2,5	25	125
7053426M	3/4"	26x3	10	50
705116M	1"	16x2	25	125
7051162M	1"	16x2,25	25	125
705120M	1"	20x2	25	125
7051205M	1"	20x2,5	25	125
705126M	1"	26x3	10	50



Raccordo a "T" doppio per tubo multistrato in ottone giallo.  
Yellow brass tee fitting connection for multilayer pipe.

<b>800M</b>	<b>f</b>	<b>∅</b>	<b>⊗</b>	<b>⊗</b>
8001214M	14x2	14x2	25	125
8001216M	16x2	16x2	25	125
80012162M	16x2,25	16x2,25	25	125
8001220M	20x2	20x2	25	125
80012205M	20x2,5	20x2,5	25	125



Raccordo a "T" doppio per tubo multistrato in ottone cromato.  
Chromium brass tee fitting connection for multilayer pipe.

<b>801M</b>	<b>f</b>	<b>∅</b>	<b>⊗</b>	<b>⊗</b>
8011214M	14x2	14x2	25	125
8011216M	16x2	16x2	25	125
80112162M	16x2,25	16x2,25	25	125
8011220M	20x2	20x2	25	125
80112205M	20x2,5	20x2,5	25	125



Raccordo a "T" femmina per tubo multistrato in ottone giallo.  
Yellow brass female tee fitting connection for multilayer pipe.

Raccordo a "T" femmina per tubo multistrato in ottone cromato.  
Chromium brass female tee fitting connection for multilayer pipe.

<b>802M</b>	<b>f</b>	<b>Ø</b>	<b>⊗</b>	<b>⊗</b>
8021214M	1/2"	14x2	25	125
8021216M	1/2"	16x2	25	125
80212162M	1/2"	16x2,25	25	125
8021220M	1/2"	20x2	25	125
80212205M	1/2"	20x2,5	25	125
8023414M	3/4"	14x2	25	125
8023416M	3/4"	16x2	25	125
80234162M	3/4"	16x2,25	25	125
8023420M	3/4"	20x2	25	125
80234205M	3/4"	20x2,5	25	125

<b>803M</b>	<b>f</b>	<b>Ø</b>	<b>⊗</b>	<b>⊗</b>
8031214M	1/2"	14x2	25	125
8031216M	1/2"	16x2	25	125
80312162M	1/2"	16x2,25	25	125
8031220M	1/2"	20x2	25	125
80312205M	1/2"	20x2,5	25	125
8033414M	3/4"	14x2	25	125
8033416M	3/4"	16x2	25	125
80334162M	3/4"	16x2,25	25	125
8033420M	3/4"	20x2	25	125
80334205M	3/4"	20x2,5	25	125



Raccordo a "T" maschio per tubo multistrato in ottone giallo.  
Yellow brass male tee fitting connection for multilayer pipe.

Raccordo a "T" maschio per tubo multistrato in ottone cromato.  
Chromium brass male tee fitting connection for multilayer pipe.

<b>804M</b>	<b>f</b>	<b>Ø</b>	<b>⊗</b>	<b>⊗</b>
8041214M	1/2"	14x2	25	125
8041216M	1/2"	16x2	25	125
80412162M	1/2"	16x2,25	25	125
8041220M	1/2"	20x2	25	125
80412205M	1/2"	20x2,5	25	125
8043414M	3/4"	14x2	25	125
8043416M	3/4"	16x2	25	125
80434162M	3/4"	16x2,25	25	125
8043420M	3/4"	20x2	25	125
80434205M	3/4"	20x2,5	25	125

<b>805M</b>	<b>f</b>	<b>Ø</b>	<b>⊗</b>	<b>⊗</b>
8051214M	1/2"	14x2	25	125
8051216M	1/2"	16x2	25	125
80512162M	1/2"	16x2,25	25	125
8051220M	1/2"	20x2	25	125
80512205M	1/2"	20x2,5	25	125
8053414M	3/4"	14x2	25	125
8053416M	3/4"	16x2	25	125
80534162M	3/4"	16x2,25	25	125
8053420M	3/4"	20x2	25	125
80534205M	3/4"	20x2,5	25	125



Raccordo curvo in ottone giallo.  
 Completo di adattatori tenuta gomma per tubo rame.

*Yellow brass elbow fitting with rubber fittings for copper pipe.*

<b>810G</b>	<b>f</b>	<b>⊠</b>	<b>⊞</b>
8101218G	18 x 18	25	125
8103422G	22 x 22	10	50

Raccordo curvo in ottone cromato.  
 Completo di adattatori tenuta gomma per tubo rame.

*Chromium brass elbow fitting with rubber fittings for copper pipe.*

<b>811G</b>	<b>f</b>	<b>⊠</b>	<b>⊞</b>
8111218G	18 x 18	25	125
8113422G	22 x 22	10	50



Raccordo curvo maschio in ottone giallo.  
 Completo di adattatori tenuta gomma per tubo rame.

*Yellow brass male elbow fitting with rubber fittings for copper pipe.*

<b>814G</b>	<b>f</b>	<b>⊠</b>	<b>⊞</b>
8141218G	1/2" x 18	25	125
8143418G	3/4" x 18	25	125
8143422G	3/4" x 22	10	50
814122G	1" x 22	10	50

Raccordo curvo maschio in ottone cromato.  
 Completo di adattatori tenuta gomma per tubo rame.

*Chromium brass male elbow fitting with rubber fittings for copper pipe.*

<b>815G</b>	<b>f</b>	<b>⊠</b>	<b>⊞</b>
8151218G	1/2" x 18	25	125
8153418G	3/4" x 18	25	125
8153422G	3/4" x 22	10	50
815122G	1" x 22	10	50



Raccordo curvo femmina in ottone giallo.  
Completo di adattatore tenuta gomma per tubo rame.  
*Yellow brass female elbow fitting with rubber fitting for copper pipe.*

<b>812G</b>	<b>f</b>	<b>×</b>	<b>⊗</b>
8121218G	1/2" x 18	25	125
8123418G	3/4" x 18	25	125
8123422G	3/4" x 22	10	50
812122G	1" x 22	10	50



Raccordo curvo femmina in ottone cromato.  
Completo di adattatori tenuta gomma per tubo rame.  
*Chromium brass female elbow fitting with rubber fittings for copper pipe.*

<b>813G</b>	<b>f</b>	<b>×</b>	<b>⊗</b>
8131218G	1/2" x 18	25	125
8133418G	3/4" x 18	25	125
8133422G	3/4" x 22	10	50
813122G	1" x 22	10	50



Raccordo curvo femmina flangiato in ottone giallo.  
Completo di adattatore tenuta gomma per tubo rame.  
*Yellow brass female wall bearing elbow fitting with rubber fitting for copper pipe.*

<b>820G</b>	<b>f</b>	<b>×</b>	<b>⊗</b>
8201218G	1/2" x 18	25	125



Raccordo curvo femmina flangiato in ottone cromato.  
Completo di adattatori tenuta gomma per tubo rame.  
*Chromium brass female wall bearing elbow fitting with rubber fittings for copper pipe.*

<b>821G</b>	<b>f</b>	<b>×</b>	<b>⊗</b>
8211218G	1/2" x 18	25	125



Niplex maschio in ottone giallo.  
Completo di adattatore tenuta gomma per tubo rame.  
*Yellow brass male fitting connection for copper pipe.*

<b>704G</b>	<b>f</b>	<b>⊗</b>	<b>⊗</b>
7041218G	1/2" x 18	50	250
7043418G	3/4" x 18	25	125
704118G	1" x 18	25	125
7043422G	3/4" x 22	25	125
704122G	1" x 22	25	125



Niplex maschio in ottone cromato.  
Completo di adattatore tenuta gomma per tubo rame.  
*Chromium brass male fitting connection for copper pipe.*

<b>705G</b>	<b>f</b>	<b>⊗</b>	<b>⊗</b>
7051218G	1/2" x 18	50	250
7053418G	3/4" x 18	25	125
705118G	1" x 18	25	125
7053422G	3/4" x 22	25	125
705122G	1" x 22	25	125



Niplex femmina in ottone giallo.  
Completo di adattatore tenuta gomma per tubo rame.  
*Yellow brass female fitting connection for copper pipe.*

<b>708G</b>	<b>f</b>	<b>⊗</b>	<b>⊗</b>
7081218G	1/2" x 18	50	250
7083418G	3/4" x 18	25	125
708118G	1" x 18	25	125
7083422G	3/4" x 22	25	125
708122G	1" x 22	25	125



Niplex femmina in ottone cromato.  
Completo di adattatore tenuta gomma per tubo rame.  
*Chromium brass female fitting connection for copper pipe.*

<b>709G</b>	<b>f</b>	<b>⊗</b>	<b>⊗</b>
7091218G	1/2" x 18	50	250
7093418G	3/4" x 18	25	125
709118G	1" x 18	25	125
7093422G	3/4" x 22	25	125
709122G	1" x 22	25	125



Niplex doppio in ottone giallo.  
Completo di adattatore tenuta gomma per tubo rame.  
*Yellow brass double fitting connection for copper pipe.*

<b>710G</b>	<b>f</b>	<b>⊗</b>	<b>⊗</b>
7101218G	18 x 18	25	125
7103422G	22 x 22	25	125

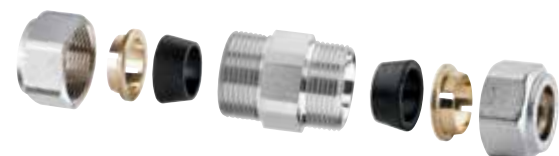

Niplex doppio in ottone cromato.  
Completo di adattatore tenuta gomma per tubo rame.  
*Chromium brass double fitting connection for copper pipe.*

<b>711G</b>	<b>f</b>	<b>⊗</b>	<b>⊗</b>
7111218G	18 x 18	25	125
7113422G	22 x 22	25	125



Raccordo a "T" in ottone giallo.  
Completo di adattatori tenuta gomma per tubo rame.  
*Yellow brass tee fitting with rubber fittings for copper pipe.*

<b>800G</b>			
8001218G	18 x 18 x 18	20	100



Raccordo a "T" in ottone cromato.  
Completo di adattatori tenuta gomma per tubo rame.  
*Chromium brass tee fitting with rubber fittings for copper pipe.*

<b>801G</b>			
8011218G	18 x 18 x 18	20	100



Raccordo a "T" femmina in ottone giallo.  
Completo di adattatori tenuta gomma per tubo rame.  
*Yellow brass female tee fitting with rubber fittings for copper pipe.*

<b>802G</b>			
8021218G	1/2" x 18	25	125
8023418G	3/4" x 18	20	100



Raccordo a "T" femmina in ottone cromato.  
Completo di adattatori tenuta gomma per tubo rame.  
*Chromium brass female tee fitting with rubber fittings for copper pipe.*

<b>803G</b>			
8031218G	1/2" x 18	25	125
8033418G	3/4" x 18	20	100



Raccordo a "T" maschio in ottone giallo.  
Completo di adattatori tenuta gomma per tubo rame.  
*Yellow brass male tee fitting with rubber fittings for copper pipe.*

<b>804G</b>			
8041218G	1/2" x 18	25	125
8043418G	3/4" x 18	20	100



Raccordo a "T" maschio in ottone cromato.  
Completo di adattatori tenuta gomma per tubo rame.  
*Chromium brass male tee fitting with rubber fittings for copper pipe.*

<b>805G</b>			
8051218G	1/2" x 18	25	125
8053418G	3/4" x 18	20	100



**Ricambio** attacco tubo rame Ø18 / Ø22 monocono in gomma.

**Spare part** compression fitting connection for Ø18 / Ø22 copper pipe, rubber monocone.

<b>722</b>			
Gialla - Yellow			
72218	Ø18	50	250
72222	Ø22	50	250
Cromata - Chromium-plated			
72218C	Ø18	50	250
72222C	Ø22	50	250

**Solo per articoli predisposti Ø18 / Ø22 mm.**

**Only for articles suitable for Ø18 / Ø22 mm.**



Raccordo a compressione attacco tubo rame Ø18.

Compression fitting connection for Ø18 copper pipe.

<b>723</b>			
Gialla - Yellow			
72318	Ø18	50	250
Cromata - Chromium-plated			
72318C	Ø18	50	250

**Applicabile su articoli con attacco 24x19 standard.**

**Non adatto per collegamenti sottotraccia.**

**Only for articles with standard fitting thread 24x19.**

**Not use for undertrack connections.**



Monocono in gomma EPDM per attacco tubo rame.

Compression rubber monocone, connection for copper pipe.

<b>724</b>		
72410	Ø10	100
72412	Ø12	100
72414	Ø14	100
72415	Ø15	100
72416	Ø16	100
72418	Ø18	100
72422	Ø22	100



Anello adattatore in ottone per serraggio tubo rame.

Brass adapter for copper pipe.

<b>725</b>		
72510	Ø10	100
72512	Ø12	100
72514	Ø14	100
72515	Ø15	100
72516	Ø16	100
72518	Ø18	100
72522	Ø22	100



Ranella guida tubo in ottone.

Brass washer.

<b>726</b>		
72610	Ø10	100
72612	Ø12	100
72614	Ø14	100



Chiave poligonale per calotte esagono 24 e 27 mm.

Polygon spanner for 24 and 27 mm hexagon nuts.

<b>637</b>		
637	24-27	1



Calotta cromata filetto 24x19 esagono 27 mm.

Chromium-plated brass nut thread 24x19 hexagon 27mm.

<b>321C</b>		
32116C	Ø16	50
32118C	Ø18	50
32120C	Ø20	50



Calotta gialla filetto 24x19 esagono 27 mm.

Brass nut thread 24x19 hexagon 27mm.

<b>321</b>		
32116	Ø16	50
32118	Ø18	50
32120	Ø20	50

Raccordi tre pezzi  
Three pieces connections



Raccordo 3 pezzi diritto in ottone giallo con attacchi filettati maschio-femmina (tenuta metallica + O-ring).

Three pieces straight yellow brass union with male/female threaded connections.

700		
70012	1/2"	25
70034	3/4"	25
7001	1"	10
700114	1"1/4	10



Raccordo 3 pezzi diritto in ottone cromato con attacchi filettati maschio-femmina (tenuta metallica + O-ring).

Three pieces straight chromium-plated brass union with male/female threaded connectons.

702		
70212	1/2"	25
70234	3/4"	25
7021	1"	10
702114	1"1/4	10



Raccordo 3 pezzi curvo in ottone giallo con attacchi filettati maschio-femmina (tenuta metallica + O-ring).

Three pieces elbow yellow brass union with male/female threaded connections.

701		
70112	1/2"	25
70134	3/4"	25
7011	1"	10
701114	1"1/4	10



Raccordo 3 pezzi curvo in ottone cromato con attacchi filettati maschio-femmina (tenuta metallica + O-ring).

Three pieces elbow chromium-plated brass with male/female threaded connections.

703		
70312	1/2"	25
70334	3/4"	25
7031	1"	10
703114	1"1/4	10



Riduttore esagonale filettato M/F in ottone giallo.

Yellow brass reducing fitting M/F.

715		
71512	1/2" x 3/4"	50
71534	3/4" x 1"	50
7151	1" x 1"1/4	50
71514	1/2" x 1"1/4	50



Riduttore esagonale filettato M/F in ottone cromato.

Chromium-plated reducing fitting M/F.

716		
71612	1/2" x 3/4"	50
71634	3/4" x 1"	50
7161	1" x 1"1/4	50
71614	1/2" x 1"1/4	50



Guscio apribile in plastica con viti di fissaggio per art. 830/831.

Plastic shell with fixing screws for items 830/831.

835			
83500	-	10	100



Raccordo curvo cromato per impianti sanitari attacco tubo rame, plastica e multistrato.

Elbow fitting for sanitary systems, for copper, plastic and multilayer pipe, chromium-plated.

831			
83112	1/2"	20	100



## Raccordi a pressione

Raccordi a pressione 172

## *Press fittings*

*Press fittings* 172



## UTILIZZO DEI RACCORDI A PRESSARE

### TAGLIO

Tagliare con l'apposito strumento il tubo perpendicolarmente al suo asse facendo attenzione a non ovalizzarlo.



### CALIBRATURA

Calibrare e svasare l'estremità del tubo appena tagliato con l'ideale svasatore, determinando il corretto diametro interno del tubo e creando uno smusso per evitare lo spostamento degli O-Ring durante l'inserimento del tubo.



**È assolutamente vietato l'utilizzo di qualsiasi tipo di lubrificante in quanto danneggerebbe gli O-Ring.**



### INSERIMENTO DEL RACCORDO

Inserire il tubo sul raccordo fino alla battuta, verificando che il tubo sia ben visibile attraverso le apposite aperture sull'anello di plastica (Vedi foto "A" e "B").

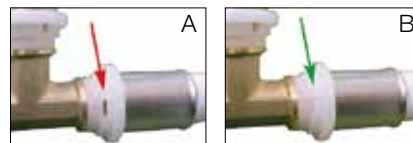

### PRESSATURA

Aprire le pinze della pressatrice.

Se si utilizzano pinze con contorno "TH" posizionare il raccordo avendo cura che il collarino di guida dell'anello di plastica sia inserito all'interno della pinza stessa.

Se si utilizzano pinze contorno "H" e "U" posizionare la pinza sulla bussola accostandola all'anello di plastica. Pressare il raccordo.

**N.B. Per un corretto utilizzo della pressatrice consultare le istruzioni d'uso della stessa.**



### VERIFICA

Al termine verificare che il raccordo sia stato pressato correttamente.





Niplex maschio.  
Male straight fitting.

<b>930</b>	<b>f</b>	<b>⊗</b>
9301216	1/2" - 16 x 2	20
9301218	1/2" - 18 x 2	20
9303420	3/4" - 20 x 2	20
9303426	3/4" - 26 x 3	10
930126	1" - 26 x 3	10
930132	1" - 32 x 3	10
9301432	1"1/4 - 32 x 3	10



Niplex femmina.  
Female straight fitting.

<b>931</b>	<b>f</b>	<b>⊗</b>
9311216	1/2" - 16 x 2	20
9311220	1/2" - 20 x 2	20
9313420	3/4" - 20 x 2	20
9313426	3/4" - 26 x 3	10
931126	1" - 26 x 3	10
931132	1" - 32 x 3	10
9311432	1"1/4 - 32 x 3	10



Niplex doppio.  
Double straight fitting.

<b>932</b>	<b>f</b>	<b>⊗</b>
9321616	16 x 2 - 16 x 2	20
9322020	20 x 2 - 20 x 2	20
9322626	26 x 3 - 26 x 3	10
9323232	32 x 3 - 32 x 3	10



Niplex riduzione.  
Reduced straight fitting.

<b>933</b>	<b>f</b>	<b>⊗</b>
9332016	20 x 2 - 16 x 2	20
9332616	26 x 3 - 16 x 2	10
9332620	26 x 3 - 20 x 2	10
9333216	32 x 3 - 16 x 2	10
9333220	32 x 3 - 20 x 2	10
9333226	32 x 3 - 26 x 3	10



Gomito maschio.  
Male elbow.

<b>940</b>	<b>f</b>	<b>⊗</b>
9401216	1/2" - 16 x 2	20
9401220	1/2" - 20 x 2	20
9403420	3/4" - 20 x 2	20
9403426	3/4" - 26 x 3	10
940132	1" - 32 x 3	10



Gomito femmina.  
Female elbow.

<b>942</b>	<b>f</b>	<b>⊗</b>
9421216	1/2" - 16 x 2	20
9421220	1/2" - 20 x 2	20
9423420	3/4" - 20 x 2	20
9423426	3/4" - 26 x 3	10
942132	1" - 32 x 3	10



Gomito doppio.  
Double elbow.

<b>943</b>	<b>f</b>	<b>⊗</b>
9431616	16 x 2 - 16 x 2	20
9432020	20 x 2 - 20 x 2	20
9432626	26 x 3 - 26 x 3	10
9433232	32 x 3 - 32 x 3	10



Gomito con staffa.  
Wall bearing elbow.

<b>944</b>	<b>f</b>	<b>⊗</b>
9441216	1/2" - 16 x 2	20
9441220	1/2" - 20 x 2	20
9443420	3/4" - 20 x 2	10
9443426	3/4" - 26 x 3	10



Raccordo Tee maschio.  
Male Tee fitting.

950		
9501216	16 x 2 - 1/2" - 16 x 2	20
9501220	20 x 2 - 1/2" - 20 x 2	20
9503420	20 x 2 - 3/4" - 20 x 2	10
9501226	26 x 3 - 1/2" - 26 x 3	10
9503426	26 x 3 - 3/4" - 26 x 3	10
950132	32 x 3 - 1" - 32 x 3	10



Raccordo Tee femmina.  
Female Tee fitting.

951		
9511216	16 x 2 - 1/2" - 16 x 2	20
9511220	20 x 2 - 1/2" - 20 x 2	20
9513420	20 x 2 - 3/4" - 20 x 2	10
9511226	26 x 3 - 1/2" - 26 x 3	10
9513426	26 x 3 - 3/4" - 26 x 3	10
951132	32 x 3 - 1" - 32 x 3	10



Raccordo Tee  
Tee fitting.

952		
952161616	16 x 2 - 16 x 2 - 16 x 2	20
952202020	20 x 2 - 20 x 2 - 20 x 2	20
952262626	26 x 3 - 26 x 3 - 26 x 3	10
952323232	32 x 3 - 32 x 3 - 32 x 3	10



Raccordo Tee ridotto al centro.  
Tee fitting, reduced middle section.

953		
953201620	20 x 2 - 16 x 2 - 20 x 2	20
953261626	26 x 3 - 16 x 2 - 26 x 3	10
953262026	26 x 3 - 20 x 2 - 26 x 3	10
953321632	32 x 3 - 16 x 2 - 32 x 3	10
953322032	32 x 3 - 20 x 2 - 32 x 3	10
953322632	32 x 3 - 26 x 3 - 32 x 3	10



Raccordo Tee riduzione.  
Reduced Tee fitting.

954		
954201616	20 x 2 - 16 x 2 - 16 x 2	20
954202016	20 x 2 - 20 x 2 - 20 x 2	20
954261620	26 x 3 - 16 x 2 - 20 x 2	10
954262016	26 x 3 - 20 x 2 - 16 x 2	10
954262020	26 x 3 - 20 x 2 - 20 x 2	10
954262616	26 x 3 - 26 x 3 - 16 x 2	10
954262620	26 x 3 - 26 x 3 - 20 x 2	10
954322026	32 x 3 - 20 x 2 - 26 x 3	10
954322626	32 x 3 - 26 x 3 - 26 x 3	10
954323220	32 x 3 - 32 x 3 - 20 x 2	10
954323226	32 x 3 - 32 x 3 - 26 x 3	10



Raccordo Tee allargato al centro.  
Tee fitting, enlarged middle section.

955		
955162016	16 x 2 - 20 x 2 - 16 x 2	20
955202620	20 x 2 - 26 x 3 - 20 x 2	10
955263226	26 x 3 - 32 x 3 - 26 x 3	10



Raccordo sede piana.  
Straight fitting with flat seat.

962		
9623416	3/4" - 16 x 2	20
9623420	3/4" - 20 x 2	20



Raccordo eurocono.  
Eurocone straight fitting.

963		
9631216	1/2" - 16 x 2	20
9633416	3/4" - 16 x 2	20
9633420	3/4" - 20 x 2	20

ATTACCO 24x19  
24x19 CONNECTION



Raccordo Arteclima attacco 24x19.  
Arteclima's fitting, connection 24x19.

964		
96416	24x19 - 16 x 2	20
96420	24x19 - 20 x 2	20

ATTACCO 24x19  
24x19 CONNECTION



Raccordo Arteclima cromato attacco 24x19.  
Chromium-plated Arteclima's fitting, connection 24x19.

965		
96516	24x19 - 16 x 2	20
96520	24x19 - 20 x 2	20



Staffa fissaggio con due raccordi.  
Mounting plate with two fittings.

945		
94512	1/2" - 16 x 2	5
94534	3/4" - 20 x 2	5



Svasatore per tubi Ø 16, 20, 26.  
Reamer for pipes Ø 16, 20, 26.

960		
960	Ø 16-20-26	5



Tappo cieco.  
Stop end fitting.

961		
96116	16 x 2	20
96120	20 x 2	20
96126	26 x 3	10



# Schede tecniche

## *Technical tables*



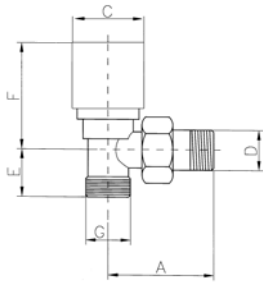

Valvola a squadra cromata.  
Angle chromium-plated radiator valve.

100	D	A	C	E	F	G
10038	3/8"	51	35	27	52	fil. 24x19
10012	1/2"	54	35	27	52	fil. 24x19

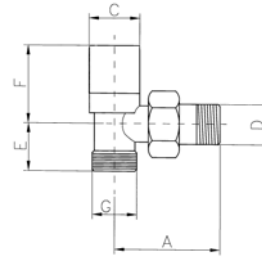

Detentore a squadra cromato.  
Angle chromium-plated lockshield.

110	D	A	C	E	F	G
11038	3/8"	51	26	27	39	fil. 24x19
11012	1/2"	54	26	27	39	fil. 24x19

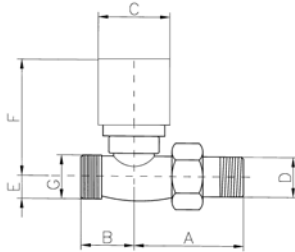

Valvola diritta cromata.  
Straight chromium-plated radiator valve.

120	D	A	B	C	E	F	G
12038	3/8"	51	27	35	12	57	fil. 24x19
12012	1/2"	54	29	35	12	57	fil. 24x19

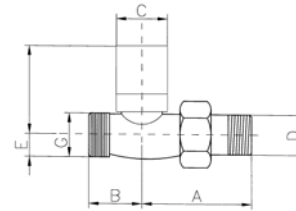

Detentore diritto cromato.  
Straight chromium-plated lockshield.

130	D	A	B	C	E	F	G
13038	3/8"	51	26	26	12	44	fil. 24x19
13012	1/2"	54	29	26	12	44	fil. 24x19

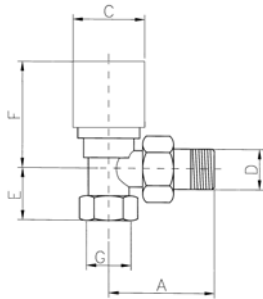

Valvola a squadra cromata attacco tubo ferro.  
Angle chromium-plated radiator valve, connection for iron pipe.

200	D	A	C	E	F	G
20038	3/8"	51	35	17	52	3/8"
20012	1/2"	54	35	27	52	1/2"

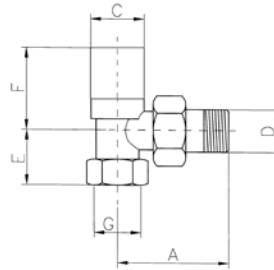

Detentore a squadra cromato attacco tubo ferro.  
Angle chromium-plated lockshield, connection for iron pipe.

210	D	A	C	E	F	G
21038	3/8"	51	26	17	39	3/8"
21012	1/2"	54	26	27	39	1/2"
21034	3/4"	58	27	24	36	3/4"
2101	1"	73	27	31	44	1"

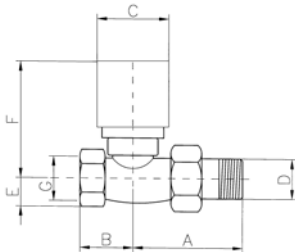

Valvola diritta cromata attacco tubo ferro.  
Straight chromium-plated radiator valve, connection for iron pipe.

220	D	A	B	C	E	F	G
22038	3/8"	51	27	35	13	57	3/8"
22012	1/2"	54	29	35	14	57	1/2"

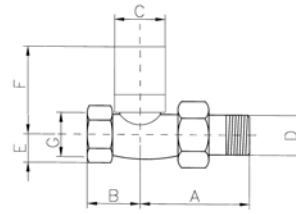

Detentore diritto cromato attacco tubo ferro.  
Straight chromium-plated lockshield, connection for iron pipe.

230	D	A	B	C	E	F	G
23038	3/8"	51	26	26	13	44	3/8"
23012	1/2"	54	29	26	14	44	1/2"
23034	3/4"	57	28	27	16	43	3/4"
2301	1"	64	36	27	21	42	1"



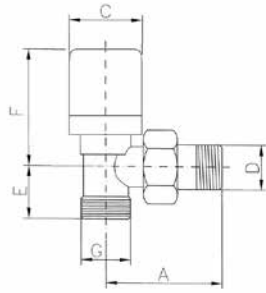

Valvola a squadra cromata termostattizzabile.  
Angle chromium-plated radiator valve with thermostatic option.

250	D	A	C	E	F	G
25038	3/8"	46	34	27	55	fil. 24x19
25012	1/2"	52	34	27	55	fil. 24x19

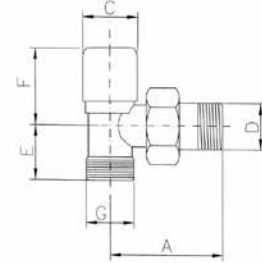

Detentore a squadra cromato.  
Angle chromium-plated lockshield.

51	D	A	C	E	F	G
5138	3/8"	46	26	24	31,5	fil. 24x19
5112	1/2"	52	26	24	31,5	fil. 24x19

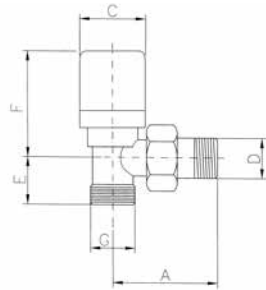

Valvola a squadra cromata termostattizzabile.  
Angle chromium-plated radiator valve with thermostatic option.

300	D	A	C	E	F	G
30038	3/8"	51	34	27	56	fil. 24x19
30012	1/2"	54	34	27	56	fil. 24x19

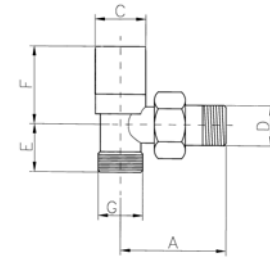

Detentore a squadra cromato.  
Angle chromium-plated lockshield.

110	D	A	C	E	F	G
11038	3/8"	51	26	27	39	fil. 24x19
11012	1/2"	54	26	27	39	fil. 24x19

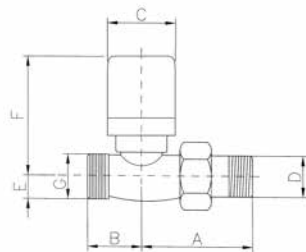

Valvola diritta cromata termostattizzabile.  
Straight chromium-plated radiator valve with thermostatic option.

301	D	A	B	C	E	F	G
30138	3/8"	51	27	34	12	61	fil. 24x19
30112	1/2"	54	29	34	12	61	fil. 24x19

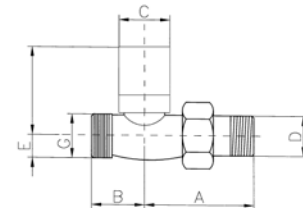

Detentore diritto cromato.  
Straight chromium-plated lockshield.

130	D	A	B	C	E	F	G
13038	3/8"	51	26	26	12	44	fil. 24x19
13012	1/2"	54	29	26	12	44	fil. 24x19

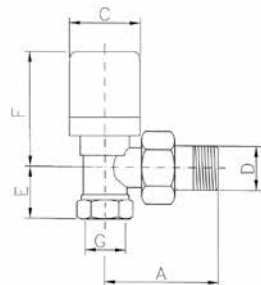

Valvola a squadra cromata termostattizzabile attacco tubo ferro.  
Angle chromium-plated radiator valve with thermostatic option, connection for iron pipe.

260	D	A	C	E	F	G
26012	1/2"	50	34	20	55	1/2"

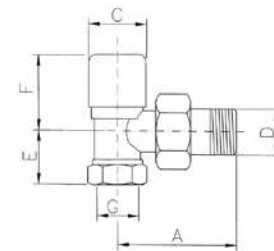

Detentore a squadra cromato attacco tubo ferro.  
Angle chromium-plated lockshield, connection for iron pipe.

61	D	A	C	E	F	G
6112	1/2"	50	26	20	31,5	1/2"

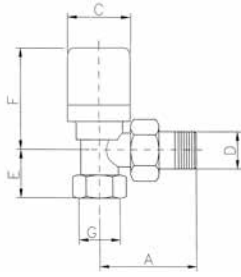

Valvola a squadra cromata termostattabile attacco tubo ferro.  
Angle chromium-plated radiator valve with thermostatic option,  
connection for iron pipe.

<b>302</b>	D	A	C	E	F	G
30238	3/8"	51	34	17	56	3/8"
30212	1/2"	54	34	27	56	1/2"
30234	3/4"	58	34	24	56	3/4"
3021	1"	73	34	31	62	1"

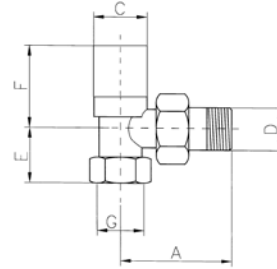

Detentore a squadra cromato attacco tubo ferro.  
Angle chromium-plated lockshield, connection for iron pipe.

<b>210</b>	D	A	C	E	F	G
21038	3/8"	51	26	17	39	3/8"
21012	1/2"	54	26	27	39	1/2"
21034	3/4"	58	27	24	36	3/4"
2101	1"	73	27	31	44	1"

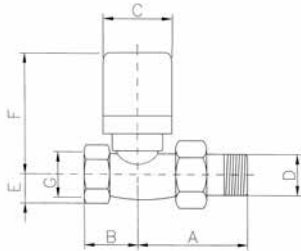

Valvola diritta cromata termostattabile attacco tubo ferro.  
Straight chromium-plated radiator valve with thermostatic option,  
connection for iron pipe.

<b>303</b>	D	A	B	C	E	F	G
30338	3/8"	51	27	34	13	61	3/8"
30312	1/2"	54	29	34	14	61	1/2"
30334	3/4"	57	28	34	16	63	3/4"
3031	1"	64	36	34	21	71	1"

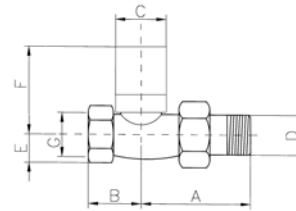

Detentore diritto cromato attacco tubo ferro.  
Straight chromium-plated lockshield, connection for iron pipe.

<b>230</b>	D	A	B	C	E	F	G
23038	3/8"	51	26	26	13	44	3/8"
23012	1/2"	54	29	26	14	44	1/2"
23034	3/4"	57	28	27	16	43	3/4"
2301	1"	64	36	27	21	42	1"

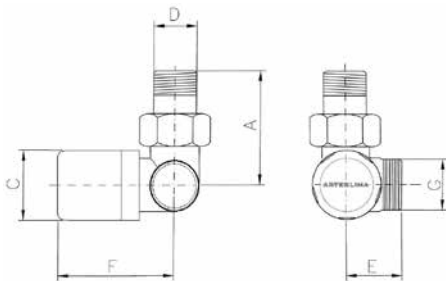

Valvola ad angolo termostattabile versione sinistra.  
Left angle radiator valve with thermostatic option.

<b>305</b>	D	A	C	E	F	G
30538	3/8"	52	34	27,5	60	fil. 24x19
30512	1/2"	52	34	27,5	60	fil. 24x19

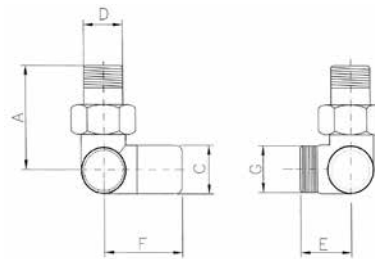

Detentore ad angolo versione destra.  
Right angle lockshield.

<b>115</b>	D	A	C	E	F	G
11538	3/8"	52	26	27,5	42,5	fil. 24x19
11512	1/2"	52	26	27,5	42,5	fil. 24x19

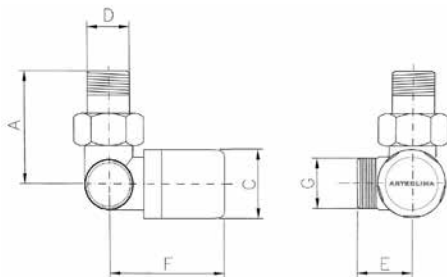

Valvola ad angolo termostattabile versione destra.  
Right angle radiator valve with thermostatic option.

<b>306</b>	D	A	C	E	F	G
30638	3/8"	52	34	27,5	60	fil. 24x19
30612	1/2"	52	34	27,5	60	fil. 24x19

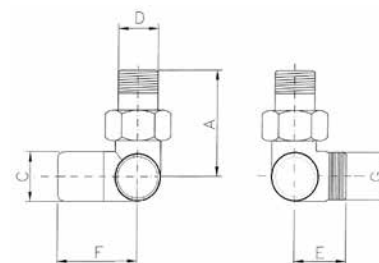

Detentore ad angolo versione sinistra.  
Left angle lockshield.

<b>116</b>	D	A	C	E	F	G
11638	3/8"	52	26	27,5	42,5	fil. 24x19
11612	1/2"	52	26	27,5	42,5	fil. 24x19

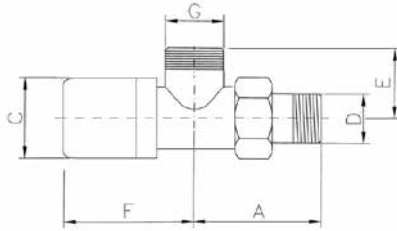

Valvola cromata termostattabile con comando orizzontale.  
Chromium-plated thermostatic radiator valve with horizontal control.

<b>304</b>	D	A	C	E	F	G
30438	3/8"	54	34	27	57	fil. 24x19
30412	1/2"	54	34	27	57	fil. 24x19

**CARATTERISTICHE TECNICHE**

- Corpo in ottone CW617N, norma UNI EN 12165
- Vitoni in ottone CW614N, norma UNI EN 12164
- Guarnizioni in EPDM perossido, norma UNI EN 681-1
- Manopola ABS bianco RAL9010
- Pressione massima d'esercizio 10 bar
- Campo di temperatura 5 ÷ 100°C
- Fluido di impiego acqua - soluzioni glicolate (max 30%)

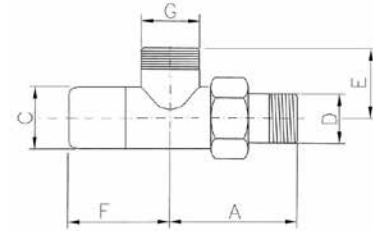

Detentore cromato con comando orizzontale.  
Chromium-plated lockshield with horizontal control.

<b>104</b>	D	A	C	E	F	G
10438	3/8"	54	26	27	40	fil. 24x19
10412	1/2"	54	26	27	40	fil. 24x19

**TECHNICAL DATA**

- Brass body CW617N, according to UNI EN 12165
- Brass screw stem CW614N, according to UNI EN 12164
- O-ring of EPDM peroxide, according to UNI EN 681-1
- White ABS RAL9010 handle
- Max operating pressure 10 bar
- Temperature range 5 ÷ 100°C
- Working fluid water - glycon fluid (max 30%)

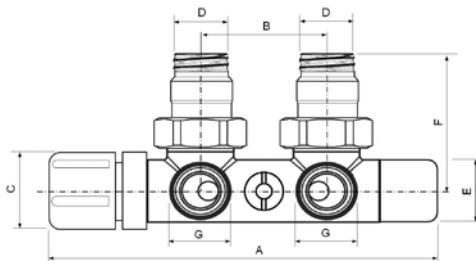

Valvola mono/bitubo termostattabile.  
Thermostatic single-double pipe valve.

**4010 - 4011 - 4012 - 4021**

	D	A	B	C	E	F	G
401012	1/2"	153	50	34	26	52	fil. 24x19
401112	1/2"	153	50	34	26	52	fil. 24x19
402012	1/2"	153	50	34	26	52	3/4" EK
402112	1/2"	153	50	34	26	52	3/4" EK

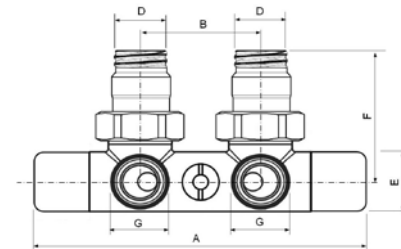

Doppio detentore mono/bitubo.  
Single-double pipe lockshield.

**4012 - 4022**

	D	A	B	E	F	G
401212	1/2"	134	50	26	52	fil. 24x19
402212	1/2"	134	50	26	52	3/4" EK

## 4010 - 4020

Valvola termostattabile monotubo / bitubo, interasse 50 mm versione destra

Thermostatic single/double pipe valve, center distance connections 50 mm, right version

## 4011 - 4021

Valvola termostattabile monotubo / bitubo, interasse 50 mm versione sinistra

Thermostatic single/double pipe valve, center distance connections 50 mm, left version

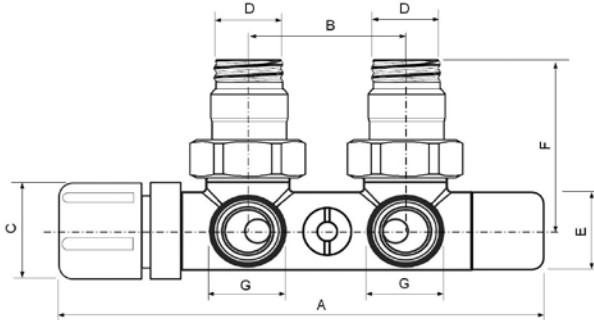

	D	A	B	C	E	F	G
401012	1/2"	153	50	34	26	52	fil. 24x19
401112	1/2"	153	50	34	26	52	fil. 24x19
402012	1/2"	153	50	34	26	52	3/4" EK
402112	1/2"	153	50	34	26	52	3/4" EK

VERSIONE DESTRA / RIGHT VERSION

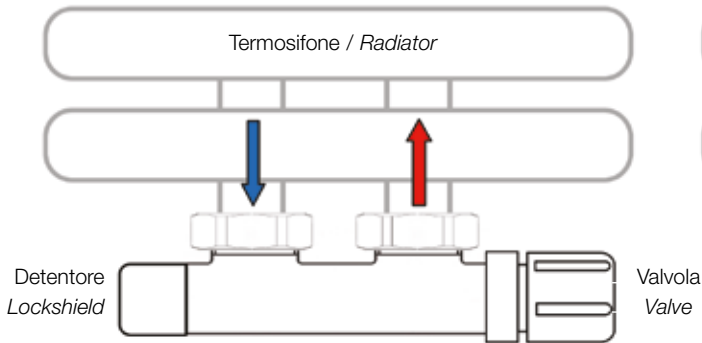

VERSIONE SINISTRA / LEFT VERSION

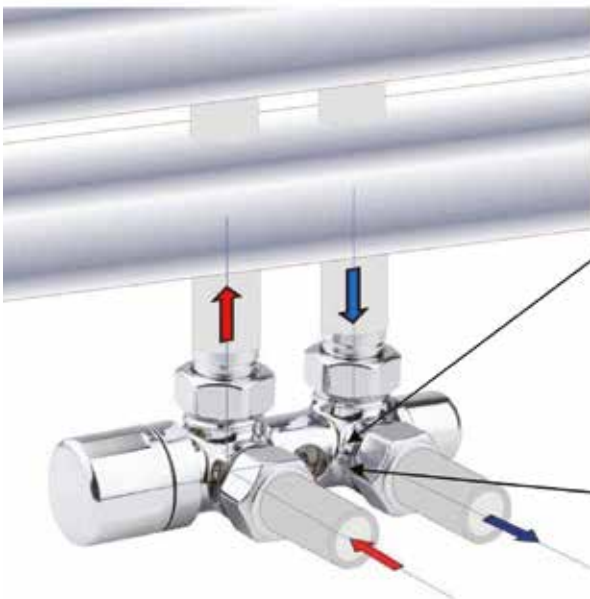
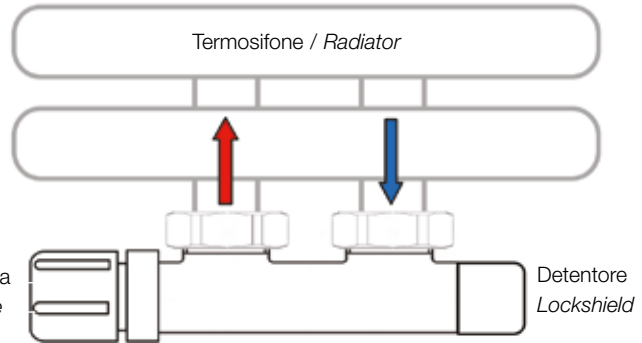

By-pass chiuso  
Closed bypass



By-pass aperto  
Opened bypass



VERSIONE BITUBO  
DOUBLE PIPE VERSION

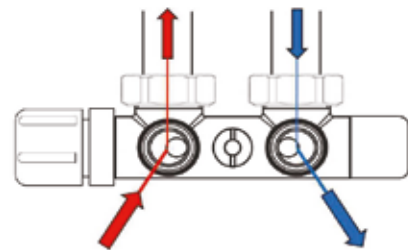

VERSIONE MONOTUBO  
SINGLE PIPE VERSION

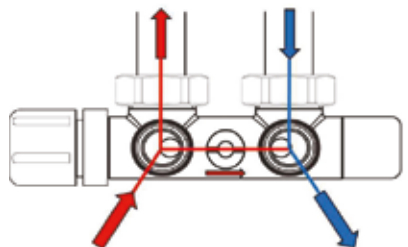

**4030 - 4035**  
**Valvola by-pass differenziale diritta e a squadra**  
**Angle- and straight differential by-pass valve**

**4030 - 4035 CARATTERISTICHE TECNICHE**

- Temperatura d'esercizio max 95° C
- Pressione di utilizzo max 6 bar
- Pressione differenziale (regolabile) 0,1-0,5 bar

**4030 - 4035 TECHNICAL DATA**

- Operating temperature max 95° C
- Operating pressure max 6 bar
- Differential pressure (adjustable) 0,1-0,5 bar

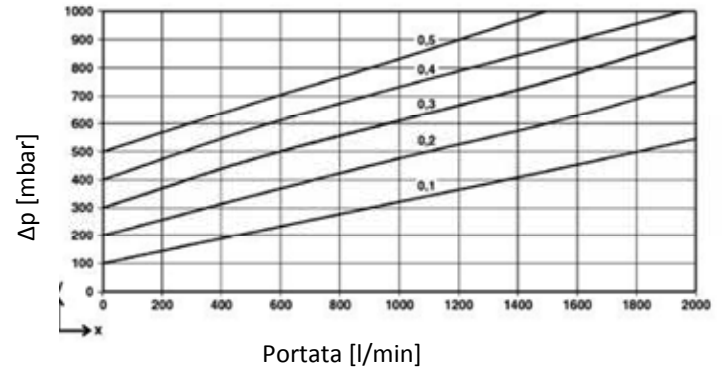
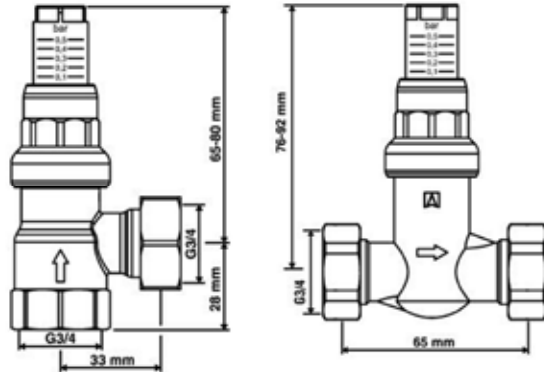

**4004**  
**Valvola monotubo**  
**One pipe valve**

Valvola monotubo termostattizzabile.  
Derivazioni 24x19, completa di sonda.

*Single pipe radiator valve with thermostatic option and probe connections 24x19.*

**4005**  
**Valvola bitubo**  
**Double pipe valve**

Valvola bitubo termostattizzabile.  
Derivazioni 24x19, completa di sonda.

*Double pipe radiator valve with thermostatic option and probe connections 24x19.*

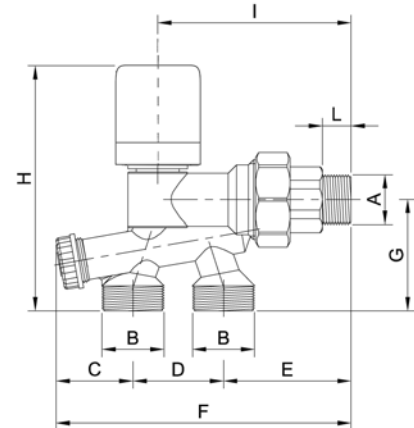

4004-4005	A	B	C	D	E	F	G	H	I	L
400412-400512	1/2"	24x19	28	38	53	120	46	102	81	12
400434-400534	3/4"	24x19	28	38	53	120	46	102	81	12
40041-40051	1"	24x19	28	38	59	126	46	102	87	12

**CARATTERISTICHE TECNICHE**

- Corpo in ottone CW617N, norma UNI EN 12165
- Vitoni in ottone CW614N, norma UNI EN 12164
- Guarnizioni in EPDM perossido, norma UNI EN 681-1
- Manopola ABS bianco RAL9010
- Pressione massima d'esercizio 10 bar
- Campo di temperatura 5 ÷ 100°C
- Fluido di impiego acqua - soluzioni glicolate (max 30%)
- Interasse derivazioni 38 mm

**TECHNICAL DATA**

- Brass body CW617N, according to UNI EN 12165
- Brass screw stem CW614N, according to UNI EN 12164
- O-ring of EPDM peroxide, according to UNI EN 681-1
- Handle of white ABS RAL9010
- Max operating pressure 10 bar
- Temperature range 5 ÷ 100°C
- Working fluid water - glycon fluid (max 30%)
- Center distance 38 mm

**4004**  
**Valvola monotubo**  
**Single pipe valve**

Asta di regolazione  
Adjusting rod

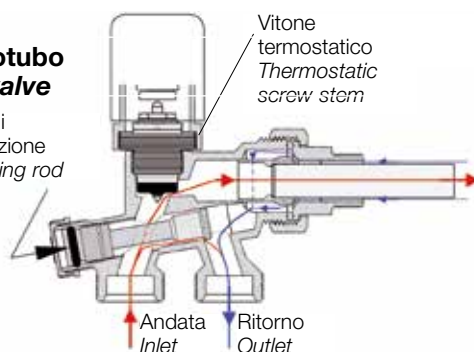

**4005**  
**Valvola bitubo**  
**Double pipe valve**

Asta di regolazione  
Adjusting rod

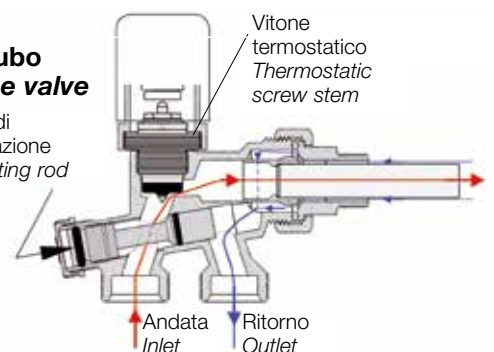

**310LL - 310BB - 310BC - 310MB**  
**310MR - 310MA - 310MS - 310 NO**  
**Comando termostatico**  
**Thermostatic head**

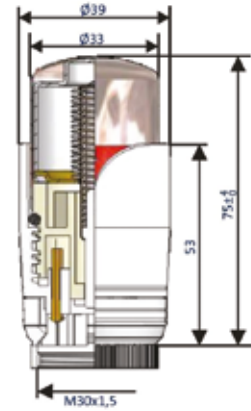
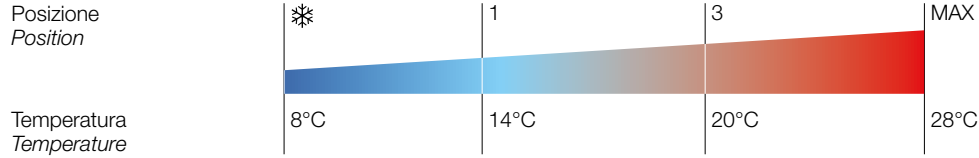

**CARATTERISTICHE TECNICHE / COSTRUTTIVE**

- Sensore incorporato ad espansione di liquido
- Campo di regolazione: da 8°C (\*) a 28°C (MAX)
- La posizione intermedia corrisponde alla regolazione "3"
- Pressione massima differenziale: 1 bar
- Pressione massima di esercizio: 10 bar
- Campo di inalterabilità elemento termostatico: -10°C / + 50°C
- Tempo di risposta totale: 22 min.
- Ghiera di fissaggio in ottone CW614N
- Attacco: M30x1,5
- Dispositivo classificato "a bassa inerzia termica"

**TECHNICAL DATA / CONSTRUCTION CHARACTERISTICS**

- With expansion liquid sensor
- Setting range: from 8° C (\*) to 28° C (MAX)
- The intermediate setting is at position "3"
- Maximum differential pressure: 1 bar
- Maximum operating pressure: 10 bar
- Inalterability range thermostatic element -10 ° C / 50 ° C
- Total response time: 22 min.
- Fastening ring nut of brass CW614N
- Connections: M30X1,5
- Classified as items "with low thermic inertia"

**ISTRUZIONE PER UNA CORRETTA INSTALLAZIONE / ISTRUCTION FOR PROPER INSTALLATION**

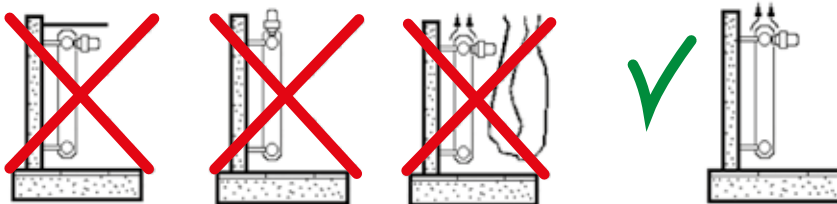

**39001**  
**Comando termostatico**  
**Thermostatic head**

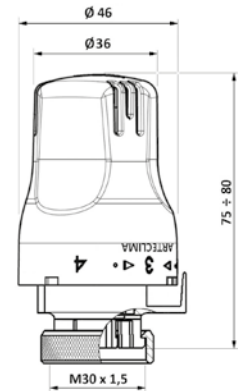
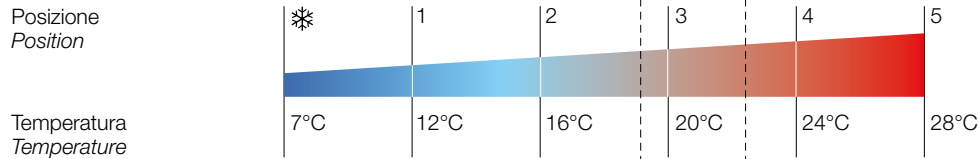

**CARATTERISTICHE TECNICHE / COSTRUTTIVE**

<b>FUNZIONI</b>	
Scala di regolazione	❄ ÷ 5
Temperatura di comfort	20°C – pos. “3”
Sicurezza	Blocco e limitazione della temperatura
<b>PRESTAZIONI</b>	
Temperatura minima di regolazione	7°C – posizione antigelo ❄
Temperatura massima di regolazione	30°C – pos. “5”
Pressione massima di esercizio	10 bar
Pressione massima differenziale	1 bar
Temperatura ambiente massima	40°C
Isteresi	< 0,5 K
Tempo di risposta	22 min.
Campo di inalterabilità dell'elemento termostatico	-15°C ÷ +60°C

**ISTRUZIONE PER UNA CORRETTA INSTALLAZIONE / ISTRUCTION FOR PROPER INSTALLATION**

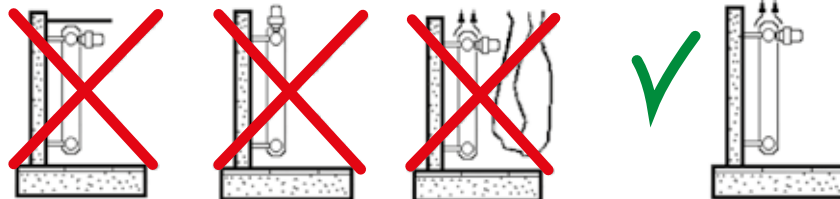

I valori di temperatura sono indicativi poiché dipendono da diversi fattori esterni ad esempio il corretto dimensionamento dell'impianto oppure la presenza di ostacoli. Pertanto: la lettura della temperatura potrà essere imprecisa se presenti condizioni particolari nell'ambiente (alcuni esempi a fianco).

**INSTALLAZIONE:** Svitare il cappuccio o manopola dalla valvola. Posizionare la regolazione del comando termostatico sul “5”. Montare il comando avvitando a fondo la ghiera attacco M30x1,5 (non utilizzare chiavi).

**NOTE IMPORTANTI:** Al termine del periodo invernale di utilizzo occorre aprire in posizione “5” il comando termostatico per evitare depositi di sedimenti nell'otturatore valvola. Per un corretto funzionamento dell'impianto si consiglia l'installazione, tra andata e ritorno, di una valvola di by-pass differenziale. In posizione ❄ (antigelo) l'otturatore chiude la valvola termostatica ad una temperatura ambiente superiore ai 10°C.

**DISPOSIZIONI MINISTERIALI:** Il sistema “Art. 39001 + Valvola termostaticabile ARTECLIMA (conforme alla Norma EN215) è un dispositivo classificato “a bassa inerzia termica” ed è quindi rispondente ai requisiti previsti dal D.M. dell'Economia e delle Finanze, “Disposizioni in materia di detrazioni per le spese di riqualificazione energetica del patrimonio edilizio esistente”.

**DISPONIBILE GUSCIO ANTIFURTO e MANOMISSIONE**  
Art.391 adatto per installazioni in scuole, locali pubblici ecc.

**BLOCCO E LIMITAZIONE DELLA TEMPERATURA:**

posizionare l'apposita forcilla in plastica bianca secondo lo schema.

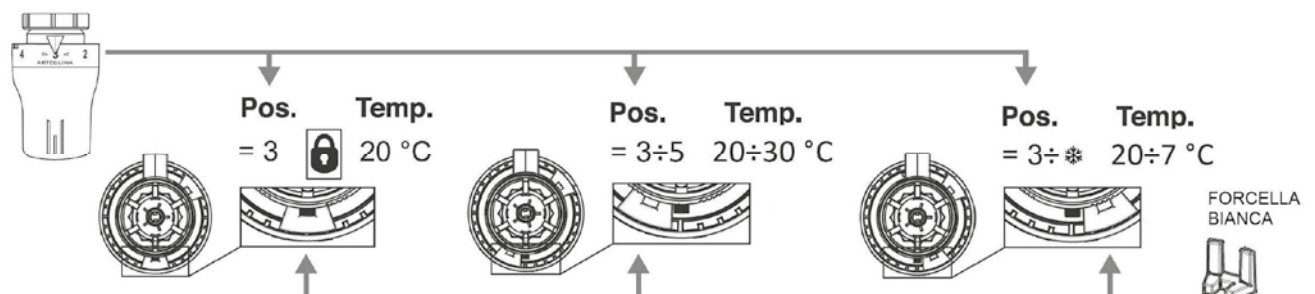

### 312

#### Comando termostatico con sensore a distanza

#### Thermostatic head with remote sensor

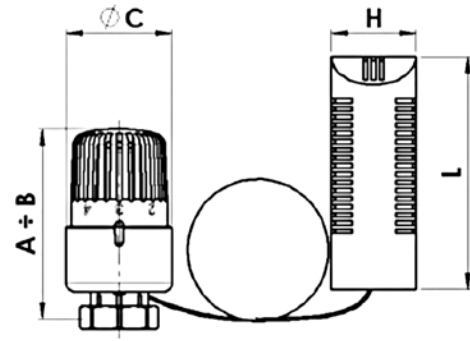
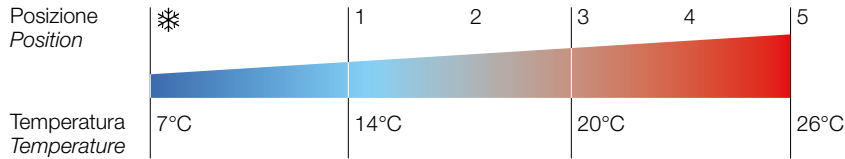

#### CARATTERISTICHE TECNICHE

- Sensore incorporato ad espansione di liquido
- Campo di regolazione: da 7°C (\*) a 26°C (5)
- La posizione intermedia corrisponde alla regolazione "3"
- Pressione massima differenziale: 1 bar
- Pressione massima di esercizio: 10 bar
- Campo di inalterabilità elemento termostatico: -10°C / + 50°C
- Tempo di risposta totale: 25 min.
- Attacco: M30x1,5
- Manopola di regolazione e coperchio in ABS
- Conforme norma EN215, dispositivo classificato "a bassa inerzia termica"

#### TECHNICAL DATA

- Whit expansion liquid sensor
- Setting range: from 7° C (\*) to 26° C (5)
- The intermediate setting is at position "3"
- Maximum differential pressure: 1 bar
- Maximum operating pressure: 10 bar
- Inalterability range thermostatic element -10 ° C / 50 ° C
- Total response time: 25 min.
- Connections: M30X1,5
- Regulating handle and cap of ABS
- According to the EN 215 and classified as items with low thermic inertia

312	A	B	C	F	H	L
	78	85	46	M30x1,5	36	100

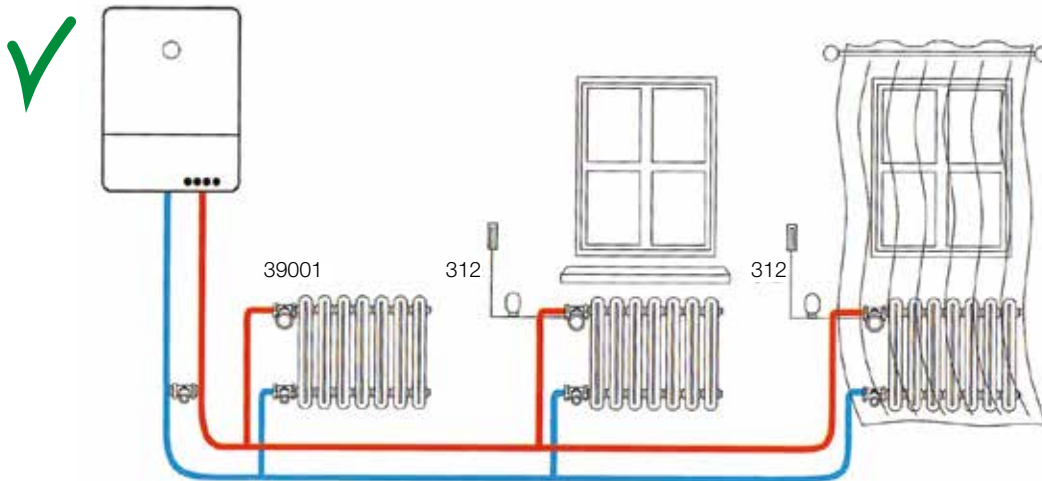

#### ISTRUZIONE PER UNA CORRETTA INSTALLAZIONE / ISTRUCTION FOR PROPER INSTALLATION

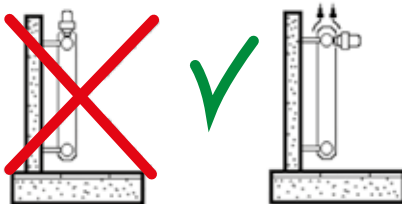



## 315

### Azionatore elettrotermico Electrothermal actuator

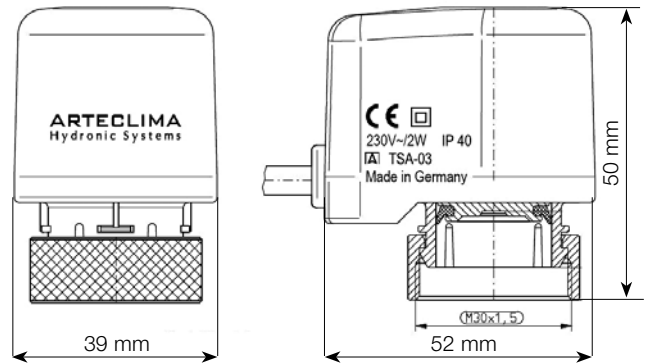

#### CARATTERISTICHE TECNICHE

• Modo di lavoro	Senza corrente normalmente chiuso
• Forza della molla	80 +15/-10N
• Tipo di connessione	M30x1,5-IG
• Voltaggio	24 V - 230 V
• Lunghezza del cavo	1 m con cavo e guaina, uscita del cavo dietro
• Tipo di protezione	IP40
• Colore stampa	grigio
• Corsa	3,0 mm tempo di apertura 3 minuti tempo di chiusura fino a 6 minuti in base alla temperatura ambiente
• Temperatura ambiente	Massimo 60° C
• Visualizzazione apertura	Segnalata da una parte mobile che sale
• Colore	Attuatore bianco, ghiera di montaggio ottone nickelato

#### TECHNICAL DATA

• Operating mode	Without energy closed valve
• Power of the spring	80 +15/-10N
• Threaded connection	M30x1,5-IG
• Voltage	24 V - 230V
• Cable length	1 m with wire and sleeve, exit of cable on the back
• Type of protection	IP40
• Print colour	Gray
• Stroke	3,0 mm opening time 3 minutes closing time up to 6 minutes in dependence of ambiental temperature
• Ambient temperature	Max 60° C
• Shift signaling	Signed by a mobile part going up
• Colour	Cover white, threaded nut nickel-plated

## 319

### Azionatore elettrotermico regolabile Adjustable electrothermal actuator

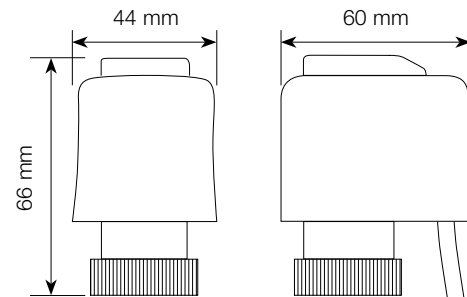

#### CARATTERISTICHE TECNICHE

• Modo di lavoro	Senza corrente normalmente chiuso
• Forza della molla	110N
• Tipo di connessione	M30x1,5-IG
• Voltaggio	230 V
• Corrente a regime	≤0,015 A
• Potenza a regime	3,45 W
• Lunghezza del cavo	0,75 m
• Tipo di protezione	IP54
• Temperatura di esercizio	≤50° C
• Tempi di apertura/chiusura	180 secondi
• Conformità	CE
• Portata micro ausiliario	1 A
• Corsa	3 posizioni selezionabili

#### TECHNICAL DATA

• Operating mode	Without energy closed valve
• Power of the spring	110N
• Threaded connection	M30x1,5-IG
• Voltage	230 V
• Operating current	≤0,015 A
• Operating power	3,45 W
• Cable length	0,75 m
• Type of protection	IP54
• Operating temperature	≤50° C
• opening/closing time	180 seconds
• Compliance	CE
• Micro auxiliary capacity	1 A
• Stroke	3 selectable positions

## 504 - 505 - 506 - 507

### Valvole sfogo aria - Air vent valves

#### CARATTERISTICHE TECNICHE E COSTRUTTIVE

- Pressione massima d'esercizio 10 bar
- Resistenza massima strutturale 20 bar
- Temperatura massima di esercizio 110°C
- Tenute: NBR - EPDM
- L'ottimale funzionamento della valvola e la relativa garanzia si ottiene impiegando la stessa con acqua priva di impurità.

Filettatura ISO 228/1	G 3/8"	G 1/2"
Filettatura NPT	3-8"	1-2"

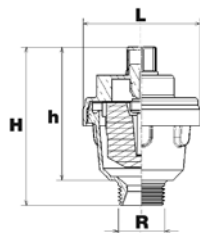

Valvola di sfogo aria automatica tipo medio.

Automatic air vent valve, type medium.

504	R	D	h	H	L	g
	3/8"	33	60	70	41	180
	1/2"	33	60	70	41	190

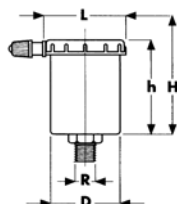

Valvola sfogo aria automatica con sfogo laterale.

Automatic air vent valve with side discharging.

506	R	D	h	H	L	g
	3/8"	38	49	-	44	180
	1/2"	38	49	-	44	180

#### TECHNICAL DATA AND CONSTRUCTION CHARACTERISTICS

- Max operating pressure 10 bar
- Max structural resistance 20 bar
- Max operating temperature 110°C
- Sealing: NBR - EPDM
- The air vent valve optimal working and the relative warrantee could be reached only using it with water free of impurity.

Thread ISO 228/1	G 3/8"	G 1/2"
Thread NPT	3-8"	1-2"

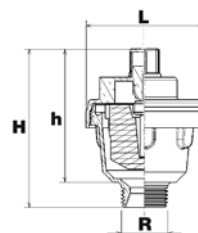

Valvola di sfogo aria automatica tipo easy.

Automatic air vent valve, type easy.

505	R	D	h	H	L	g
	3/8"	33	50	60	41	180
	1/2"	33	50	60	41	190

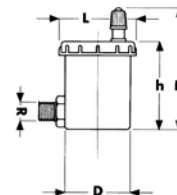

Valvola sfogo aria automatica con attacco laterale.

Automatic air vent valve with side connection.

507	R	D	h	H	L	g
	3/8"	39	52	68	46	180
	1/2"	39	52	68	46	180

## 500 - 501 - 502 - 503

### Valvole sfogo aria - Air vent valves

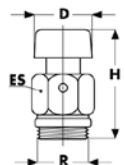

Valvola di sfogo aria manuale per radiatori. Filetto a tenuta Teflon.

Manual air vent valve for radiators Teflon thread seal.

500	R	ES	H	D
	1/4"	13	30	18
	3/8"	17	30	18

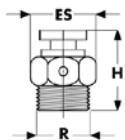

Valvola sfogo aria manuale con tenuta O-ring.

Manual air vent valve with O-ring seal.

502	R	ES	H
	1/4"	13	26
	3/8"	17	26

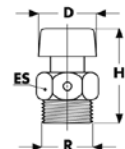

Valvola di sfogo aria manuale per radiatori.

Manual air vent valve for radiators.

501	R	ES	H	D
	1/4"	13	30	18
	3/8"	17	30	18
	1/2"	23	30	18

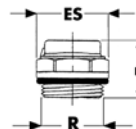

Valvola di sfogo aria manuale per radiatori con possibilità di rotazione dello scarico. Filetto tenuta O-ring.

Manual air vent valve for radiators with adjustable drain.

503	R	ES	H
	3/8"	22	19
	1/2"	22	19

## 565 - 565F

### Valvola di sicurezza

### Safety valve

Valvole di sicurezza a membrana.

Diaphragm safety valves.

#### CARATTERISTICHE TECNICHE

- Pressione massima d'esercizio 10 bar
- Temperatura massima 100°C
- Sovrapressione apertura 10%
- Scarto di chiusura 20% (minimo 0,6 bar)
- Attacchi F/F - M/F ISO 228-1

#### TECHNICAL DATA

- Max operating pressure 10 bar
- Max temperature 100°C
- Overpressure 10%
- Reseating pressure 20% (minimum 0,6 bar)
- Connections F/F - M/F ISO 228-1

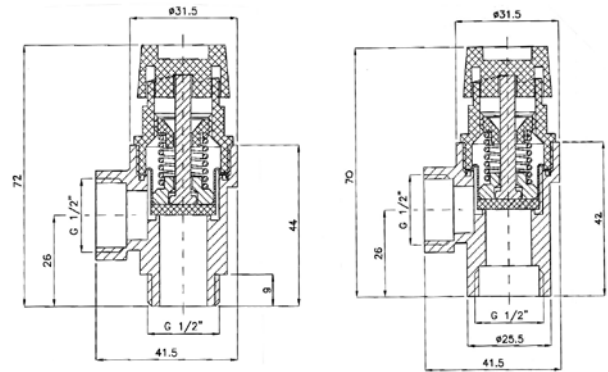

## 579

### Riduttore di pressione

### Pressure reducing

#### CAMPO DI UTILIZZO

- Impianti idrici con pressione max 25 bar
- Temperatura massima 80°C
- Campo di regolazione a valle 0,5 - 7 bar
- Raccordi M/M filetto ISO 228-1

#### RANGE OF APPLICATION

- Max inlet pressure waterworks 25 bar
- Max operating temperature 80°C
- Adjustable outlet 0,5 - 7 bar
- M/M connections ISO 228-1

	DN	H	L
57912	1/2"	153	165
57934	3/4"	164	195

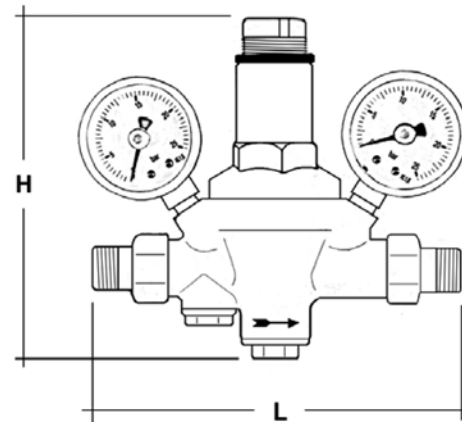

#### Diagramma di portata e perdita di carico

#### Discharge and head loss diagram

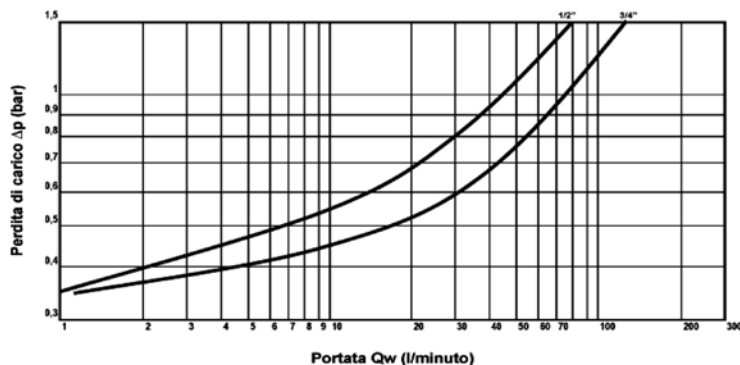

## 572

### Riduttore di pressione Pressure reducing

Riduttore di pressione con attacchi F/F nichelato  
con attacco manometro.

Nickel pressure reducing with F/F and gauge connection.

#### CARATTERISTICHE TECNICHE

Massima pressione in entrata:	15 bar
Campo di regolazione a valle:	1 - 4 bar
Temperatura massima di utilizzo:	80° C
Filettature di collegamento:	ISO 228/1
Fluidi conformi:	Acqua, aria compressa.
Rapporto di riduzione:	5 : 1

#### TECHNICAL DATA

- Max inlet pressure: 15 bar
- Field of action (outlet pressure): 1 - 4 bar
- Max temperature of use: 80° C
- Threading of connection: ISO 228/1
- Suitable fluids: Water, compressed air
- Reduction rate: 5 : 1

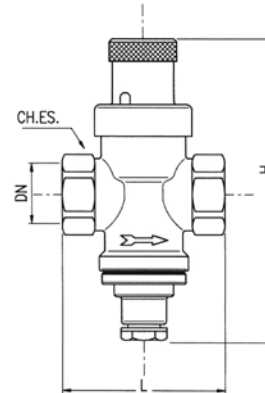

#### Diagramma di portata e perdita di carico Discharge and head loss diagram



## 573

### Riduttore di pressione Pressure reducing

Riduttore di pressione con raccordi F/F - sede Inox.

Pressure reducing with F/F fittings and Inox seat.

#### CARATTERISTICHE TECNICHE

Massima pressione in entrata:	25 bar
Campo di regolazione a valle:	0,5 - 6 bar
Temperatura massima di utilizzo:	80° C
Filettature di collegamento:	ISO 228/1
Fluidi conformi:	Acqua, aria compressa.
Rapporto di riduzione:	10 : 1

#### TECHNICAL DATA

- Max inlet pressure: 25 bar
- Field of action (outlet pressure): 0,5 - 6 bar
- Max temperature of use: 80° C
- Threading of connection: ISO 228/1
- Suitable fluids: Water, compressed air
- Reduction rate: 10 : 1

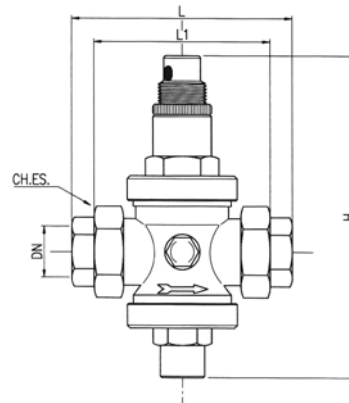

#### Diagramma di portata e perdita di carico Discharge and head loss diagram

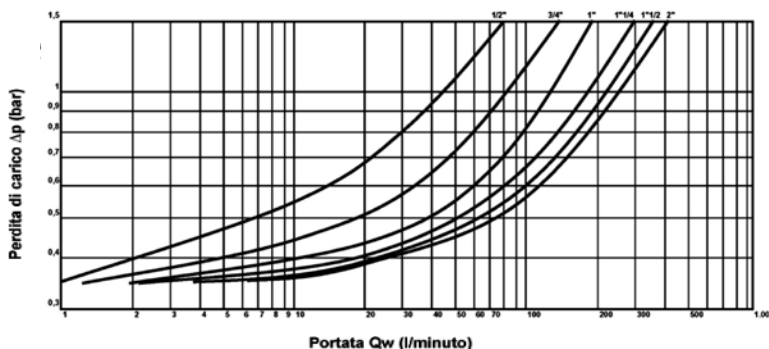

## 574 - 575

### Riduttori di pressione Pressure reducing

#### CARATTERISTICHE TECNICHE

- Riduttori di pressione PN25 fabbricati in ottone con funzionamento a pistone
- Impianti idrici con pressione massima 25 bar
- Temperatura massima 80°C
- Campo di regolazione a valle (rapporto rid. 10:1) 0,5 - 6 bar
- Diaframma in ottone
- Attacchi manometro da 1/4" sui due lati per il controllo della pressione in uscita
- Attacchi con raccordi F.F. ISO 228-1
- Sede in acciaio inox

#### TECHNICAL DATA

- Brass water pressure reducing valves PN25 with brass diaphragm functioning
- Waterworks with max inlet pressure 25 bar
- Max operating temperature 80°C
- Adjustable outlet (reduction rate 10:1) 0,5 - 6 bar
- Brass diaphragm
- Outlet pressure gauge connections 1/4" on both sides
- F.F. connections ISO 228-1
- Stainless steel seat

574	DN	H	L	L1
57412	1/2"	120	112	75
57434	3/4"	120	134	88
5741	1"	160	140	93

Diagramma di portata e perdita di carico  
Discharge and head loss diagram

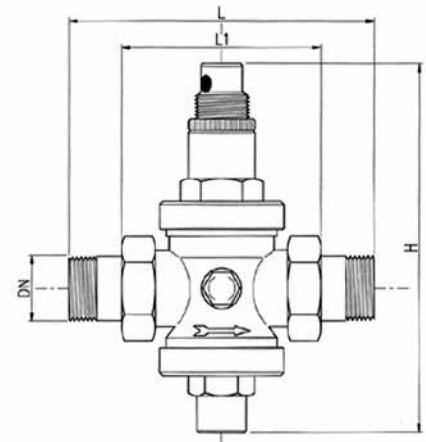
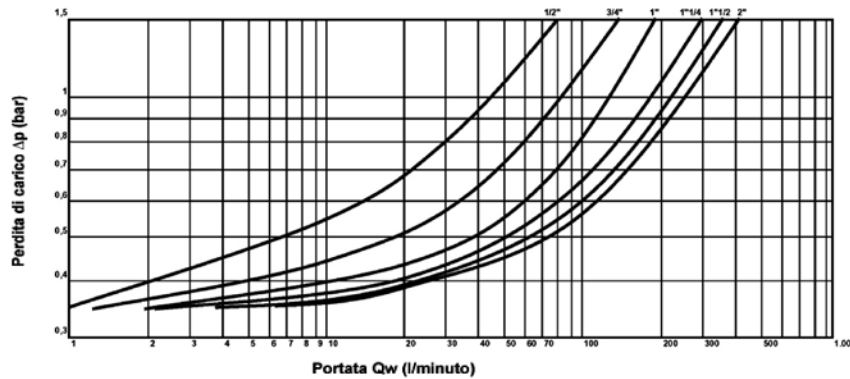

575	DN	H	L
57512	1/2"	120	75
57534	3/4"	150	85
5751	1"	160	89

Diagramma di portata e perdita di carico  
Discharge and head loss diagram

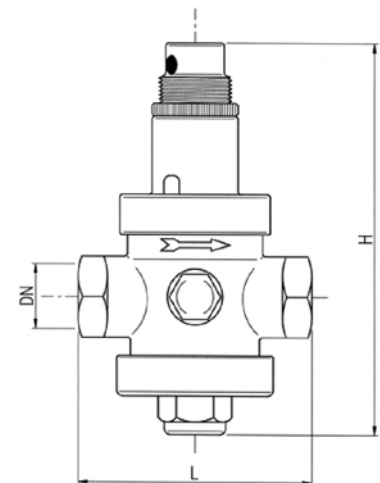
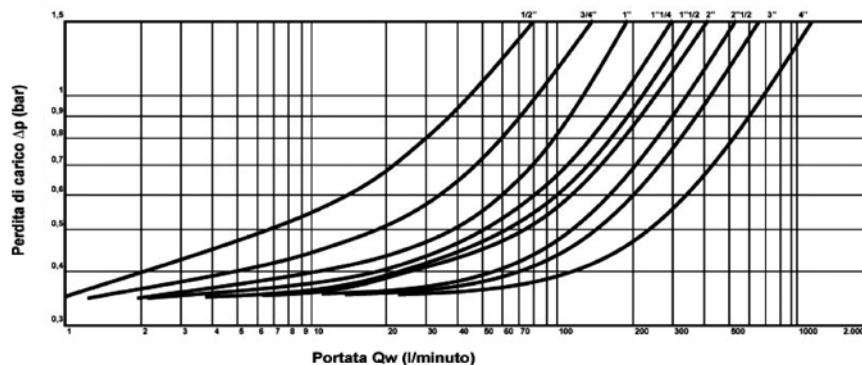

## 577 - 578

### Filtri autopulenti

### Self cleaning filters

#### CAMPO DI UTILIZZO

• Impianti idrici con pressione max	25 bar
• Temperatura massima	100°C
• Disponibile con cartuccia filtrante	100 o 300 micron
• Attacchi filettati F.F.	ISO 228-1

#### RANGE OF APPLICATION

• Waterworks with max inlet pressure	25 bar
• Max operating temperature	100°C
• Available with cartridge	100 or 300 micron
• F.F. threaded connections	ISO 228-1

577	DN	L	H	H1	H2	L1
57712	1/2"	118	250	186	165	70
57734	3/4"	118	250	186	165	70
5771	1"	123	280	212	180	72
577114	1 1/4"	123	280	212	180	72
577112	1 1/2"	153	320	250	214	98

578	DN	L	H	H1	H2	L1
57812	1/2"	118	250	186	165	70
57834	3/4"	118	250	186	165	70
5781	1"	123	280	212	180	72
578114	1 1/4"	123	280	212	180	72
578112	1 1/2"	153	320	250	214	98

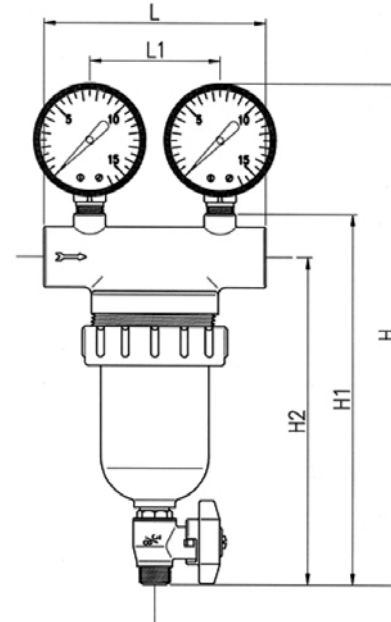

#### Diagramma di portata e perdita di carico

#### Discharge and head loss diagram

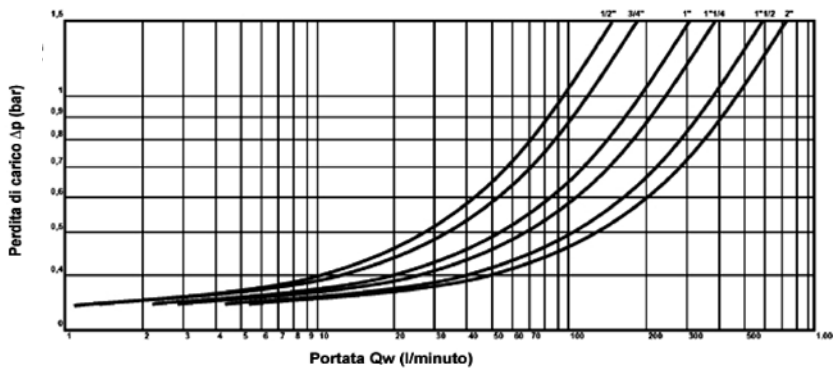

## 588 - 589

### Defangatori

### Dirt separators

#### CAMPO DI UTILIZZO

• Impianti idrici con pressione max	10 bar
• Temperatura massima	100°C
• Magnete (se inserito)	6.000 Gauss
• Attacchi filettati	ISO 228-1

#### RANGE OF APPLICATION

• Waterworks with max inlet pressure	10 bar
• Max operating temperature	100°C
• Magnetic (optional)	6.000 Gauss
• Threaded connections	ISO 228-1

588	DN	L	H	589	DN	L	H
58834	3/4"	115	234	58934	3/4"	115	234
5881	1"	115	234	5891	1"	115	234
588114	1 1/4"	137	165	589114	1 1/4"	137	165
588112	1 1/2"	137	165	589112	1 1/2"	137	165

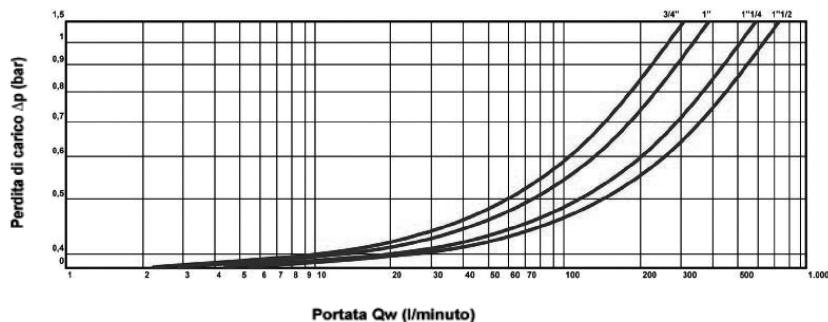
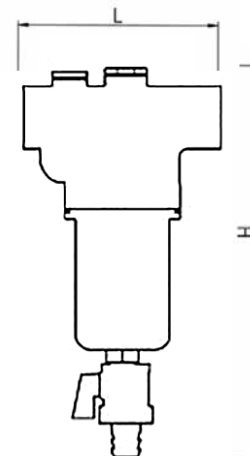

## 580 - 581

### Valvole di zona a sfera

### Ball zone valves

#### CARATTERISTICHE TECNICHE

- L'otturatore a sfera a passaggio totale non oppone alcuna resistenza al passaggio del fluido.
- Pressione massima di esercizio 10 bar
- Temperatura dei fluidi da -20°C a +100°C
- Corpo della valvola in ottone
- Otturatore a sfera in ottone cromato
- Sedi di tenuta della sfera in PTFE
- OR di tenuta in EPDM

581	A	B	C	D
58112	1/2"	62	89	95
58134	3/4"	71	100	100
5811	1"	83	118	105

Valvola di zona a sfera a due vie M/F.  
Disponibile nei diametri 1/2", 3/4" e 1" con un attacco femmina e un attacco maschio con codolo per facilitare l'installazione.

*Ball zone valve with two ways M/F.  
Available diameters 1/2", 3/4" and 1" with female connections and a male connection with a tang for easier installation.*

580	A	B	C	D
58034	3/4"	66	39	100
5801	1"	76	45	105

Valvola di zona a sfera a tre vie F/F.  
Disponibile nei diametri 3/4" e 1" con attacchi femmina.

*Ball zone valve with three ways F/F.  
Available diameters 3/4" and 1" with female connections.*

#### TECHNICAL DATA

- Because of its total flow section there is no drag when the fluid flows.
- Maximum operating pressure 10 bar
- Fluid temperature -20°C a +100°C
- Body Brass
- Ball screw block Chromium plated
- Ball seal seats PTFE
- Sealing O-ring EPDM

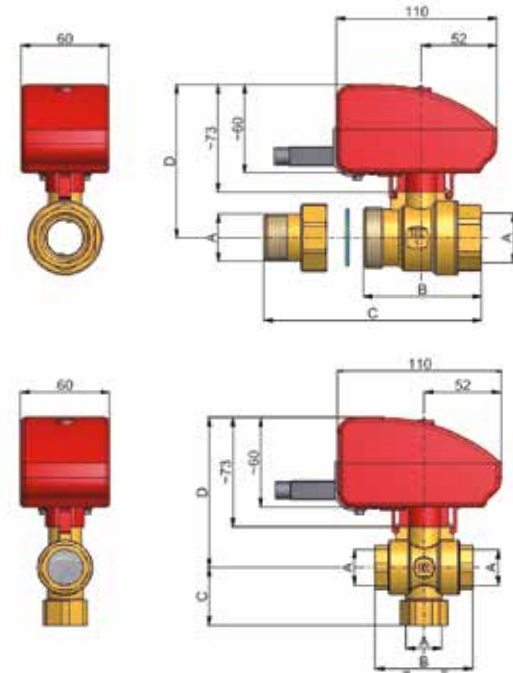

## 582

### Servocomando

### Motor



#### CARATTERISTICHE TECNICHE

- Motore unidirezionale per valvola di zona a 2 vie da azionare con termostato a 2 contatti
- Potenza assorbita 4 Watt
- Alimentazione 230 V 50 Hz
- Coppia motrice 5 Nm
- Grado di protezione IP 40
- Comando di apertura termostato con 2 contatti
- Tempo apertura/chiusura 60 secondi circa
- Contatto ausiliario libero da potenziale max 5A
- Il collegamento elettrico non richiede la messa a terra poiché i componenti interni sono isolati.

#### TECHNICAL DATA

- One way directional motor for 2 way zone valve to be controlled by 2 contacts thermostats
- Absorbed power 4 Watt
- Power supply 230 V 50 Hz
- Max torque 5 Nm
- IP protection IP 40
- Opening control 2 contacts thermostat
- Opening/closing time about 60 seconds
- Auxiliary contact without potential 5A max
- Ground connection is not required since the internal parts are insulated.

## 583

### Servocomando

### Motor



#### CARATTERISTICHE TECNICHE

- Motore bidirezionale per valvola di zona a 2 o 3 vie da azionare con termostato a 2 contatti
- Potenza assorbita 4 Watt
- Alimentazione 230 V 50 Hz
- Coppia motrice 5 Nm
- Grado di protezione IP 40
- Comando di apertura termostato con 2 contatti
- Rotazione 90° 60 secondi circa
- Contatto ausiliario libero da potenziale max 5A
- Il collegamento elettrico non richiede la messa a terra poiché i componenti interni sono isolati.

#### TECHNICAL DATA

- Two ways directional motor for 2 or 3 way zone valve to be controlled by 2 contacts thermostats
- Absorbed power 4 Watt
- Power supply 230 V 50 Hz
- Max torque 5 Nm
- IP protection IP 40
- Opening control 2 contacts thermostat
- 90° rotation about 60 seconds
- Auxiliary contact without potential 5A max
- Ground connection is not required since the internal parts are insulated.

## 6402 - 6403 - 6404

### Collettori modulari a regolazione manuale

#### Manual control manifolds

	D	A	B	E	H	h	I	L
640342	3/4"	106	12	32	59	43	45	67
64012	1"	106	13	39	63	43	45	71
640343	3/4"	154	12	32	59	43	45	67
64013	1"	154	13	39	63	43	45	71
640344	3/4"	201	12	32	59	43	45	67
64014	1"	201	13	39	63	43	45	71

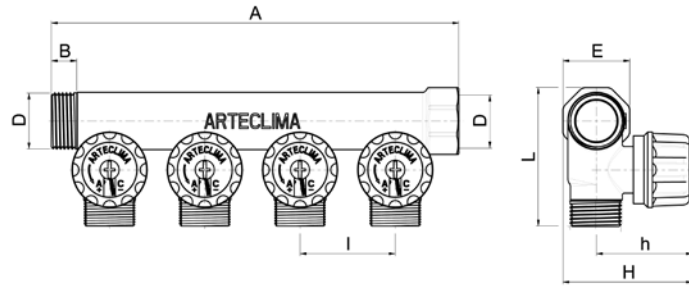

#### CARATTERISTICHE TECNICHE

- Corpo in ottone CB753S, norma UNI EN 1982
- Vitoni in ottone CW614N, norma UNI EN 12164
- Guarnizioni in EPDM perossido, norma UNI EN 681-1
- Manopola ABS bianco RAL9010
- Dischetti in alluminio serigrafato
- Pressione massima d'esercizio 11 bar
- Campo di temperatura 5 ÷ 100°C
- Fluido di impiego acqua - soluzioni glicolate (max 30%)
- Interasse derivazioni 45 mm

#### TECHNICAL DATA

- Brass body CB753S, according to UNI EN 1982
- Brass screw stem CW614N, according to UNI EN 12164
- O-ring of EPDM peroxide, according to UNI EN 681-1
- White ABS RAL9010 handle
- Disk spare double face
- Max operating pressure 11 bar
- Temperature range 5 ÷ 100°C
- Working fluid water - glycon fluid (max 30%)
- Center distance 45 mm

## 6392 - 6393 - 6394

### Collettori modulari a regolazione manuale

#### Manual control manifolds

	A	B	C	D	E	F	G
639342	3/4"	24x19	36	35	89	68	60
639343	3/4"	24x19	36	35	127	68	60
639344	3/4"	24x19	36	35	165	68	60

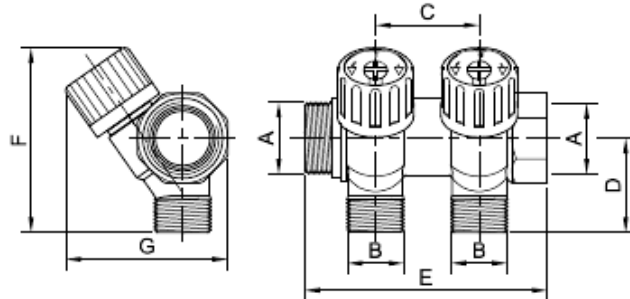

#### CARATTERISTICHE TECNICHE

- Corpo in ottone CW617N, norma UNI EN 12165
- Vitoni in ottone CW614N, norma UNI EN 12164
- Guarnizioni in EPDM perossido, norma UNI EN 681-1
- Manopola ABS bianco RAL9010
- Dischetti in alluminio serigrafato
- Pressione massima d'esercizio 11 bar
- Campo di temperatura 5 ÷ 100°C
- Fluido di impiego acqua - soluzioni glicolate (max 30%)
- Interasse derivazioni 36 mm

#### TECHNICAL DATA

- Brass body CW617N, according to UNI EN 12165
- Brass screw stem CW614N, according to UNI EN 12164
- O-ring of EPDM peroxide, according to UNI EN 681-1
- White ABS RAL9010 handle
- Disk spare double face
- Max operating pressure 11 bar
- Temperature range 5 ÷ 100°C
- Working fluid water - glycon fluid (max 30%)
- Center distance 36 mm



**630 - 631**  
**Collettori complanari**  
**Distribution manifolds**

<b>630</b>	A	B	C	D	E	F
63034	3/4"	24x19	50	38	118	78
6301	1"	24x19	60	38	134	80
<b>631</b>	A	B	C	D	E	F
63134	3/4"	24x19	50	38	118	78
6311	1"	24x19	60	38	134	80

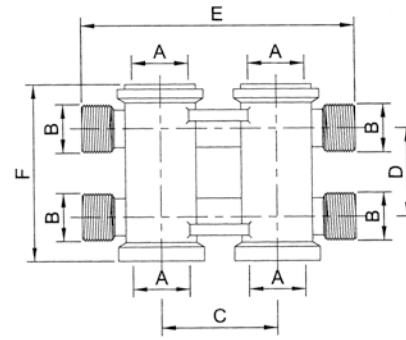

**CARATTERISTICHE TECNICHE**

- Corpo in ottone CW617N, norma UNI EN 12165
- Guarnizioni in EPDM perossido, norma UNI EN 681-1
- Pressione massima d'esercizio 11 bar
- Campo di temperatura 5 ÷ 100°C
- Fluido di impiego acqua - soluzioni glicolate (max 30%)
- Interasse derivazioni 38 mm

**TECHNICAL DATA**

- Brass body CW617N, according to UNI EN 12165
- O-ring of EPDM peroxide, according to UNI EN 681-1
- Max operating pressure 11 bar
- Temperature range 5 ÷ 100°C
- Working fluid water - glycon fluid (max 30%)
- Center distance 38 mm

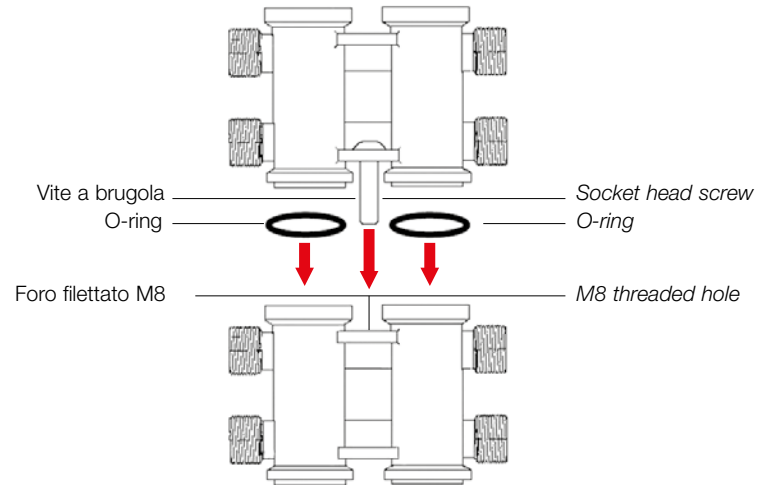

**600 - 601 - 602**  
**Collettori**  
**Manifolds**

<b>600</b>	D	A	I	B	E
60034	3/4" x 2	92	38	12	32
6001	1" x 2	94	38	13	38
<b>601</b>	D	A	I	B	E
60134	3/4" x 3	130	38	12	32
6011	1" x 3	130	38	13	38
<b>602</b>	D	A	I	B	E
60234	3/4" x 4	169	38	12	32
6021	1" x 4	169	38	13	38



**CARATTERISTICHE TECNICHE**

- Corpo in ottone CW617N, norma UNI EN 12165
- Pressione massima d'esercizio 11 bar
- Campo di temperatura 0 ÷ 110°C
- Interasse derivazioni 38 mm

**TECHNICAL DATA**

- Brass body CW617N, according to UNI EN 12165
- Max operating pressure 11 bar
- Temperature range 0 ÷ 110°C
- Center distance 38 mm

## 607VTC - 607VTE\*

Collettori di distribuzione premontati  
Pre-assembled distribution manifolds

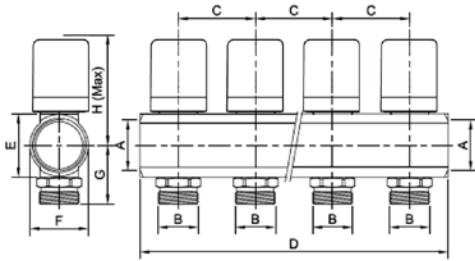

607VTC	A	B*	C	D	E	F	G	H
607VTC2	1"	24x19	50	100	41	Ø38	38	73
607VTC3	1"	24x19	50	150	41	Ø38	38	73
607VTC4	1"	24x19	50	200	41	Ø38	38	73
607VTC5	1"	24x19	50	250	41	Ø38	38	73
607VTC6	1"	24x19	50	300	41	Ø38	38	73
607VTC7	1"	24x19	50	350	41	Ø38	38	73
607VTC8	1"	24x19	50	400	41	Ø38	38	73
607VTC9	1"	24x19	50	450	41	Ø38	38	73
607VTC10	1"	24x19	50	500	41	Ø38	38	73
607VTC11	1"	24x19	50	550	41	Ø38	38	73
607VTC12	1"	24x19	50	600	41	Ø38	38	73

\* 607VTE B = 3/4" Eurocono  
B = 3/4" Eurocone

## 607DRC - 607DRE\*

Collettori di distribuzione premontati  
Pre-assembled distribution manifolds

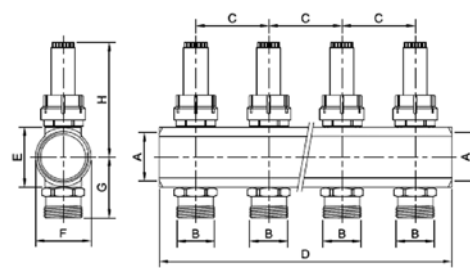

607DRC	A	B*	C	D	E	F	G	H
607DRC2	1"	24x19	50	100	41	Ø38	42	78
607DRC3	1"	24x19	50	150	41	Ø38	42	78
607DRC4	1"	24x19	50	200	41	Ø38	42	78
607DRC5	1"	24x19	50	250	41	Ø38	42	78
607DRC6	1"	24x19	50	300	41	Ø38	42	78
607DRC7	1"	24x19	50	350	41	Ø38	42	78
607DRC8	1"	24x19	50	400	41	Ø38	42	78
607DRC9	1"	24x19	50	450	41	Ø38	42	78
607DRC10	1"	24x19	50	500	41	Ø38	42	78
607DRC11	1"	24x19	50	550	41	Ø38	42	78
607DRC12	1"	24x19	50	600	41	Ø38	42	78

\* 607DRE B = 3/4" Eurocono  
B = 3/4" Eurocone

## 607VC - 607VCE\*

Collettori di distribuzione premontati  
Pre-assembled distribution manifolds

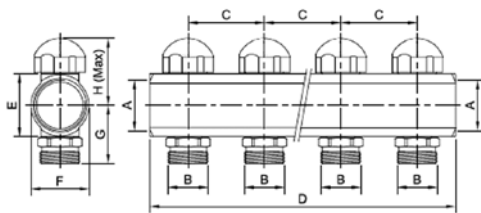

607VC	A	B*	C	D	E	F	G	H
6072VC	1"	24x19	50	100	41	Ø38	38	44
607VC3	1"	24x19	50	150	41	Ø38	38	44
607VC4	1"	24x19	50	200	41	Ø38	38	44
607VC5	1"	24x19	50	250	41	Ø38	38	44
607VC6	1"	24x19	50	300	41	Ø38	38	44
607VC7	1"	24x19	50	350	41	Ø38	38	44
607VC8	1"	24x19	50	400	41	Ø38	38	44
607VC9	1"	24x19	50	450	41	Ø38	38	44
607VC10	1"	24x19	50	500	41	Ø38	38	44
607VC11	1"	24x19	50	550	41	Ø38	38	44
607VC12	1"	24x19	50	600	41	Ø38	38	44

\* 607VE B = 3/4" Eurocono  
B = 3/4" Eurocone

## 607DC - 607DE\*

Collettori di distribuzione premontati  
Pre-assembled distribution manifolds

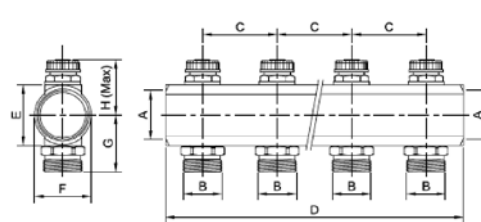

607DC	A	B*	C	D	E	F	G	H
607DC2	1"	24x19	50	100	41	Ø38	38	40
607DC3	1"	24x19	50	150	41	Ø38	38	40
607DC4	1"	24x19	50	200	41	Ø38	38	40
607DC5	1"	24x19	50	250	41	Ø38	38	40
607DC6	1"	24x19	50	300	41	Ø38	38	40
607DC7	1"	24x19	50	350	41	Ø38	38	40
607DC8	1"	24x19	50	400	41	Ø38	38	40
607DC9	1"	24x19	50	450	41	Ø38	38	40
607DC10	1"	24x19	50	500	41	Ø38	38	40
607DC11	1"	24x19	50	550	41	Ø38	38	40
607DC12	1"	24x19	50	600	41	Ø38	38	40

\* 607DE B = 3/4" Eurocono  
B = 3/4" Eurocone

### CARATTERISTICHE TECNICHE

- Corpo in ottone CW612N, norma UNI EN 12168
- Vitoni in ottone CW614N, norma UNI EN 12164
- Guarnizioni in EPDM perossido, norma UNI EN 681-1
- Manopole ABS bianco RAL9010
- Pressione massima d'esercizio 10 bar
- Campo di temperatura 5 ÷ 90°C
- Fluido di impiego acqua - soluzioni glicolate (max 30%)
- Interasse derivazioni 50 mm

### TECHNICAL DATA

- Brass body CW612N, according to UNI EN 12168
- Brass screw stem CW614N, according to UNI EN 12164
- O-ring of EPDM peroxide, according to UNI EN 681-1
- White ABS RAL9010 handle
- Max operating pressure 10 bar
- Temperature range 5 ÷ 90°C
- Working fluid water - glycon fluid (max 30%)
- Center distance 50 mm

**606C**  
Collettori da barra  
Drawn manifolds

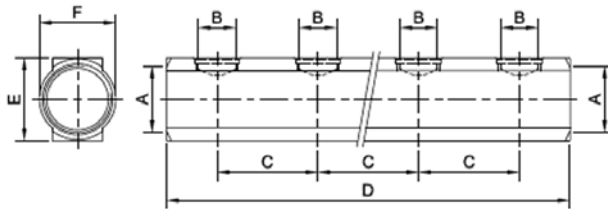

606C	A	B	C	D	E	F
60612C	1"	1/2"	50	100	41	Ø38
60613C	1"	1/2"	50	150	41	Ø38
60614C	1"	1/2"	50	200	41	Ø38
60615C	1"	1/2"	50	250	41	Ø38
60616C	1"	1/2"	50	300	41	Ø38
60617C	1"	1/2"	50	350	41	Ø38
60618C	1"	1/2"	50	400	41	Ø38
60619C	1"	1/2"	50	450	41	Ø38
606110C	1"	1/2"	50	500	41	Ø38
606111C	1"	1/2"	50	550	41	Ø38
606112C	1"	1/2"	50	600	41	Ø38

606142C	1"1/4	1/2"	50	106	50	Ø48
606143C	1"1/4	1/2"	50	156	50	Ø48
606144C	1"1/4	1/2"	50	206	50	Ø48
606145C	1"1/4	1/2"	50	256	50	Ø48
606146C	1"1/4	1/2"	50	306	50	Ø48
606147C	1"1/4	1/2"	50	356	50	Ø48
606148C	1"1/4	1/2"	50	406	50	Ø48
606149C	1"1/4	1/2"	50	456	50	Ø48
6061410C	1"1/4	1/2"	50	506	50	Ø48
6061411C	1"1/4	1/2"	50	556	50	Ø48
6061412C	1"1/4	1/2"	50	606	50	Ø48

**CARATTERISTICHE TECNICHE**

- Pressione massima di esercizio 11 bar
- Campo di temperatura 0÷110°C
- Interasse derivazioni 50 mm
- Corpo in ottone CW612N norma UNI EN 12168
- Finitura cromata.

**607C - 607E\* - 607P#**  
Collettori da barra  
Drawn manifolds

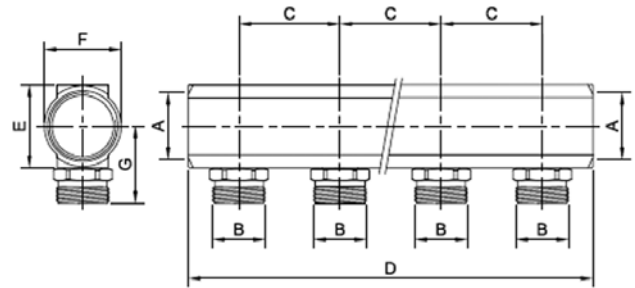

607C	A	B*#	C	D	E	F	G
6071C2	1"	24x19	50	100	41	Ø38	38
6071C3	1"	24x19	50	150	41	Ø38	38
6071C4	1"	24x19	50	200	41	Ø38	38
6071C5	1"	24x19	50	250	41	Ø38	38
6071C6	1"	24x19	50	300	41	Ø38	38
6071C7	1"	24x19	50	350	41	Ø38	38
6071C8	1"	24x19	50	400	41	Ø38	38
6071C9	1"	24x19	50	450	41	Ø38	38
6071C10	1"	24x19	50	500	41	Ø38	38
6071C11	1"	24x19	50	550	41	Ø38	38
6071C12	1"	24x19	50	600	41	Ø38	38

60714C2	1"1/4	24x19	50	106	50	Ø48	42,5
60714C3	1"1/4	24x19	50	156	50	Ø48	42,5
60714C4	1"1/4	24x19	50	206	50	Ø48	42,5
60714C5	1"1/4	24x19	50	256	50	Ø48	42,5
60714C6	1"1/4	24x19	50	306	50	Ø48	42,5
60714C7	1"1/4	24x19	50	356	50	Ø48	42,5
60714C8	1"1/4	24x19	50	406	50	Ø48	42,5
60714C9	1"1/4	24x19	50	456	50	Ø48	42,5
60714C10	1"1/4	24x19	50	506	50	Ø48	42,5
60714C11	1"1/4	24x19	50	556	50	Ø48	42,5
60714C12	1"1/4	24x19	50	606	50	Ø48	42,5

\* **607E** B = 3/4" Eurocono  
B = 3/4" Eurocone

# **607P** B = 3/4" testa piana  
B = 3/4" flat head

**TECHNICAL DATA**

- Max operating pressure 11 bar
- Temperature range 0÷110°C
- Lateral center distance 50 mm
- Body brass CW612N according to UNI EN 12168
- Chromium-plated surface.

PROUDLY MADE IN ITALY

Tutti i prodotti Arteclima sono assicurati contro i rischi di responsabilità civile.  
*All Arteclima's products are insured to the risks of public liability.*

Foto di copertina - Cover photo: Judith Everaarts - Amsterdam

## Condizioni generali di vendita

### 1. CATALOGO E LISTINO PREZZI

Il presente catalogo e relativo listino prezzi annulla e sostituisce i precedenti con effetto 01/01/2021 ed è l'unico riconosciuto come valido da ARTECLIMA srl.

### 2 ORDINI

Gli ordini, salvo approvazione da parte nostra, rimangono validi anche trascorso il termine di consegna previsto ed in ogni caso fino a quando non venga comunicato, a mezzo raccomandata, o posta certificata, espresso annullamento.

### 3 PREZZI

I prezzi, espressi in euro esclusi IVA, sono quelli del listino aggiornato al momento dell'ordine o quelli indicati nelle nostre offerte, e si intendono impegnativi solo dopo conferma d'ordine da parte nostra.

### 4 TERMINE DI CONSEGNA

Il termine di consegna si intende sempre indicato in via approssimativa; non si accordano quindi indennizzi o risarcimenti per eventuali ritardi nella consegna stessa.

### 5 SPEDIZIONI

La merce viaggia a rischio e pericolo del committente, anche se sia stata assunta l'obbligazione, complementare al contratto di vendita, di resa franco destino.

Arteclima non risponde di eventuali danni, ritardi od ammanchi subiti durante il trasporto.

Eventuali reclami dovranno essere inoltrati direttamente presso i trasportatori.

### 6 RECLAMI

Non si accettano reclami trascorsi otto giorni dal ricevimento della merce.

### 7 PAGAMENTI

Le condizioni di pagamento sono quelle riportate in sede di conferma d'ordine. In caso di inadempienza saranno applicati, a decorrere dal giorno successivo alla scadenza convenuta, gli interessi legali di mora in misura pari al tasso BCE maggiorato di 8 punti percentuali, come previsto dal D.Lgs. 231/2002: eventuali ordini in corso saranno sospesi fino all'avvenuto pagamento.

### 8 RESI

Gli articoli potranno essere resi solo dopo espressa autorizzazione da parte nostra; i pezzi dovranno essere restituiti a spese e a cura del Cliente presso il nostro indirizzo e solo dopo nostra verifica saranno sostituiti per resa franco destino.

### 9 GARANZIA

Tutti i nostri articoli sono garantiti per la durata di tre anni; la nostra garanzia rimane comunque limitata all'accettare di ritorno per la sostituzione, secondo le modalità del punto precedente, eventuali pezzi riscontrati difettosi. Rimane esclusa ogni e qualsiasi nostra responsabilità per difetti che risultassero da eventuali manomissioni degli articoli da noi forniti, errata installazione, errato uso, durante l'impiego o l'installazione degli stessi.

### 10 MODIFICHE AL PRODOTTO

Le immagini di questo catalogo si intendono a puro carattere illustrativo e possono subire variazioni. Il produttore si riserva di apportare modifiche tecniche ed estetiche agli articoli illustrati.

### 11 CONTROVERSIE LEGALI

Unico Foro competente per ogni controversia legale è il Tribunale di Novara.

## General sale terms

### 1. CATALOGUE AND PRICE LIST

*This catalogue and price list delete and replaces the previous version. It's the only one recognised as valid from 01/01/2021 by ARTECLIMA srl.*

### 2 ORDERS

*Orders are subject to our approval. They will remain valid even after the planned delivery term and in any case until express cancellation notified by registered letter or certified mail.*

### 3 PRICES

*Prices are the ones given in the price list updated as of the date of the order or those indicated in our offers. They are to be considered as binding only upon our order confirmation.*

### 4 DELIVERY TERMS

*The delivery terms are always to be considered as estimated; no refund is therefore due for possible delivery delays.*

### 5 SHIPMENTS

*The goods travel at the client's own risk, even in the case of delivery free at destination, a condition complementary to the sale contract. Arteclima will not be responsible for any damage, delay or shortage suffered during transportation. All claims must be addressed directly to the carriers.*

### 6 CLAIMS

*No claims will be accepted after eight days from receipt of the merchandise.*

### 7 PAYMENTS

*The payment terms are specified in our order confirmation. After expiry of the terms we charge of default interest at BCE rate increased by 8%.*

### 8 RETURNS

*Items can be returned only upon Arteclima's express approval; the articles must be returned at the customer's own expenses to our address, and only after verification of the malfunction will they be replaced for delivery free our warehouse.*

### 9 WARRANTY

*We give a three years warranty on our articles; our guarantee is in any case limited to acceptance of possible defective items returned for replacement, as specified in the paragraph above. The guarantee will not cover defects resulting from incorrect use, tampering and/or wrong installation of the items supplied by our company.*

### 10 ALTERATIONS ON PRODUCTS

*Images on this catalogue have only the set purpose of present the product. The producer reserves the right to make technical and aesthetic alterations on illustrated items.*

### 11 LEGAL CONTROVERSIES

*Any legal controversy will be under the jurisdiction of the Court of Novara.*





**ARTECLIMA srl**

Via Tommaso Cagnola, 15 - 28024 Gozzano (NO) - Italy  
Tel. +39 0322 81178 - info@arteclima.eu - [www.arteclima.eu](http://www.arteclima.eu)

